

ARWIS KALDIR SÜR SİSTEM SERİSİ

HB 126





HB126

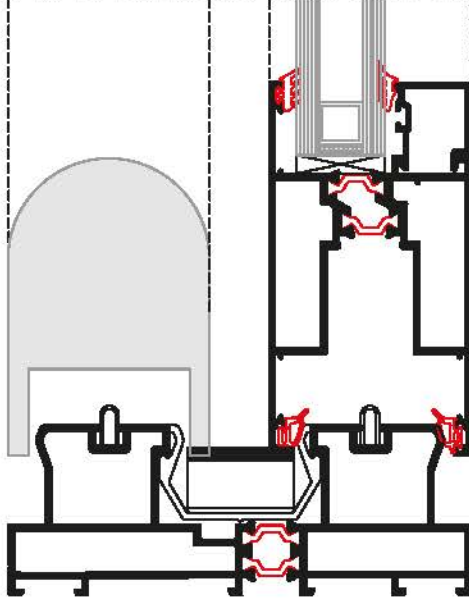

TEKNİK ÖZELLİKLER / TECHNICAL PROPERTIES

KASA DERİNLİĞİ / FRAME DEPTH	126-197mm
KANAT DERİNLİĞİ / VENT DEPTH	55mm
PROFİL ET KALINLIĞI / PROFILE WALL THCKNESS	1.8mm
MAKS. CAM KALINLIĞI / MAX. GLASS THCKNESS	36mm
ISI BARIYERLERİ / THERMAL INSULATION BAR	16mm

KULLANIM SEÇENEKLERİ / APPLICATION ALTERNATIVES	KAPI DOOR	PENCERE WINDOW
KALDIR SÜR / LIFT & SLIDE	*	*
SABİTLİ KASA / FIXED FRAME	*	*
3 RAYLI KASA / THREE RAILED FRAME	*	*

SİSTEM UF DEĞERLERİ - EN 10077-2
THERMAL INSULATION VALUE



2,94-4,51 W/(m² K)

ISI YALITIM DEĞERLERİ (UF) / THERMAL INSULATION VALUE (UF)

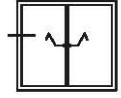
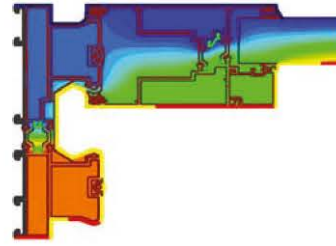
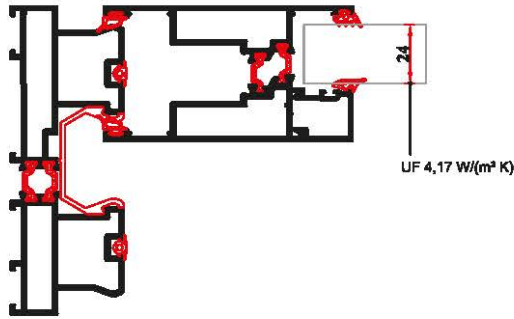

ISI YALITIM DEĞERLERİ (UF) / THERMAL INSULATION VALUE (UF)

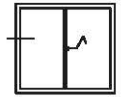
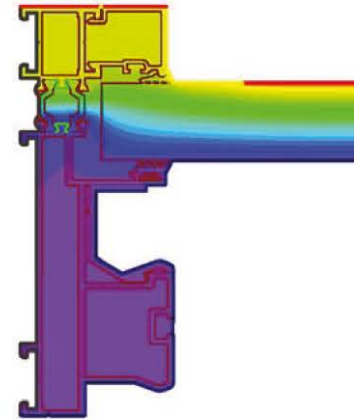
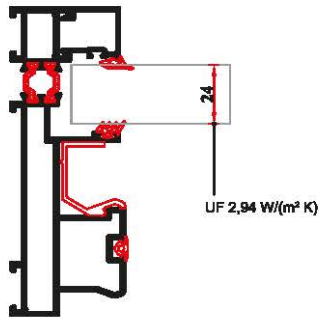

ISI YALITIM DEĞERLERİ (UF) / THERMAL INSULATION VALUE (UF)

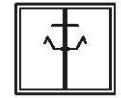
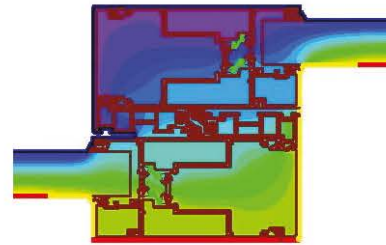
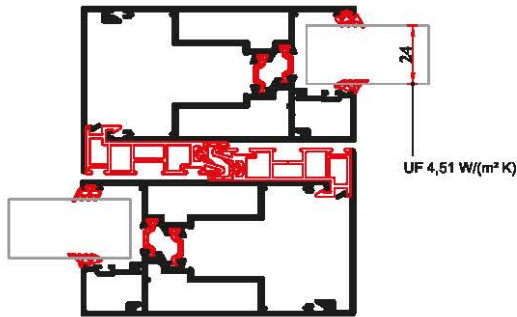

ISI YALITIM DEĞERLERİ (UF) / THERMAL INSULATION VALUE (UF)

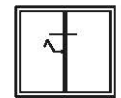
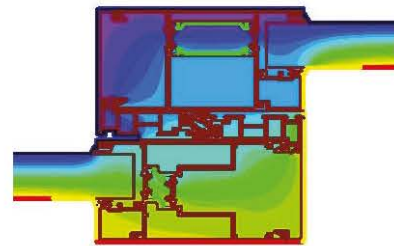
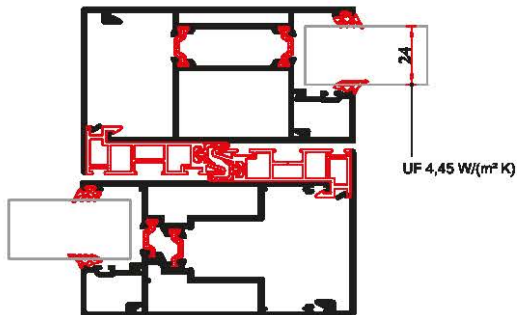

ISI YALITIM DEĞERLERİ (UF) / THERMAL INSULATION VALUE (UF)

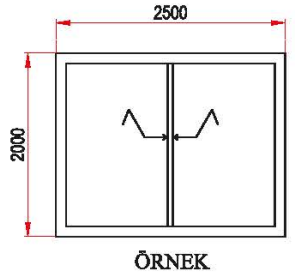
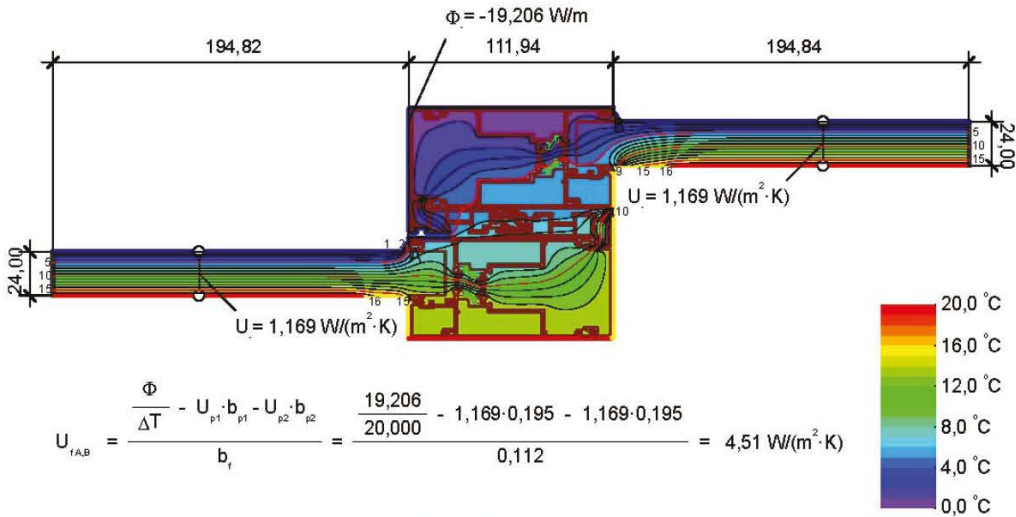
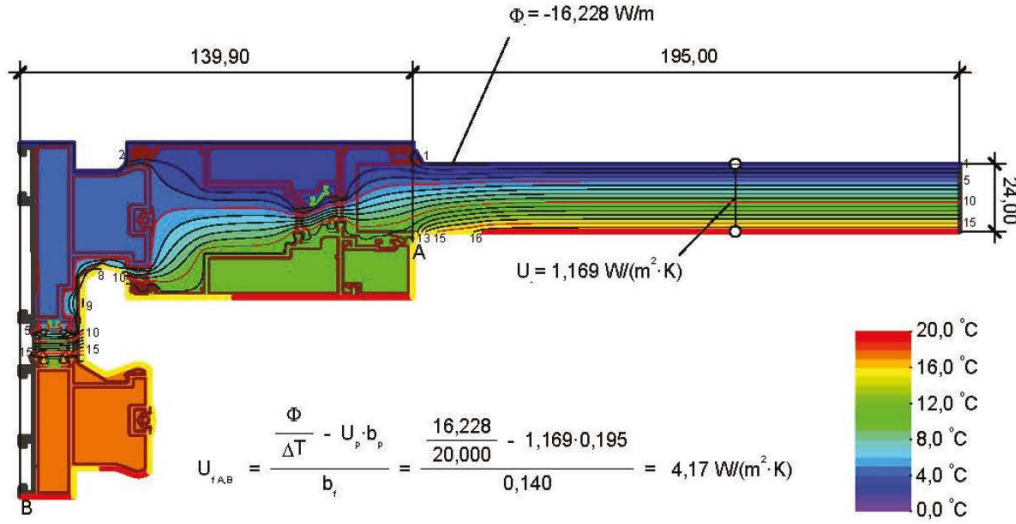

Ucw Hesaplama										
PROFİL KOMBİNASYONLARI										
Pos.	Adet	Açıklama	Genişlik [m]	Yükseklik [m]	Uf-Değeri [W/m²·K]	Alan Af [m²]	%A			
01	2	Düşey Kesit A	0,14	2	4,17	0,58	37,1%			
02	2	Yatay Kesit B	2,5	0,14	4,17	0,70	46,4%			
03	1	Düşey Kesit C	0,11	2,26	4,51	0,25	16,5%			
					Uf Ortalama	Af Toplam				
					4,23	1,5086	100,0%			
DOLGULAR										
Pos.	Adet	Açıklama	Genişlik [m]	Yükseklik [m]	Cam/Panel Ug/p-Değeri [W/m²·K]	Alan Ag/p [m²]	%A	Spacer Ψg/p [W/m·K]	Uzunluk lg/p [m]	%I
01	2	4+16+4 Düz cam	1,085	1,76	1,1	3,85	100,0%	0,04	11,42	100,0%
					Ug/p Ortalama	Ag/p Toplam		Ψg/p Ortalama	lg/p Toplam	
					1,10	3,85	100,0%	0,04	11,42	100,0%
SONUÇ			Yüzdeler							
Ucw = 2,06 W/m²·K			Profil	1,19						
A _{toplam} = 5,36 m²			Dolgu	0,79						
H _{toplam} = 11,07 W/K			Spacer	0,09						
CAD-PLAN										
$U_{cw} = \frac{\sum_i A_{g_i} \cdot U_{g_i} + \sum_j A_{f_j} \cdot U_{f_j} + \sum_k l_{f_k} \cdot \psi_{f_k}}{\sum_i A_{g_i} + \sum_j A_{f_j}}$										

SİSTEM NUMARASI

126 HB 1350-1351

126 HB 1352-1353

126 HB 1360-1361

KALIP NUMARASI

1350-1351

1352-1353

1360-1361

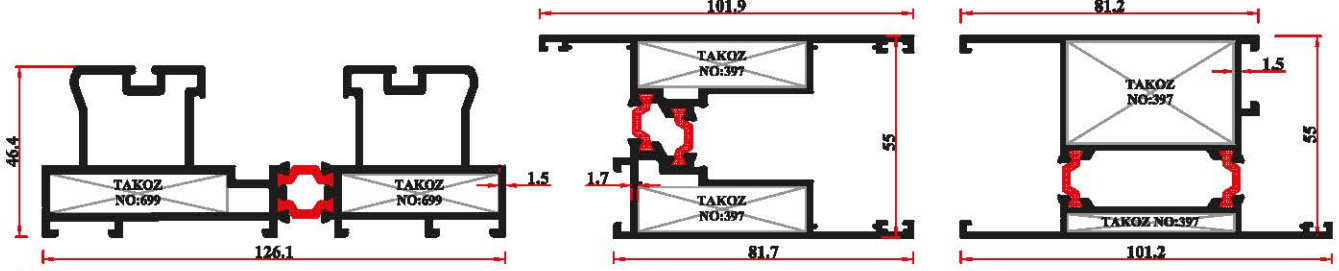

AĞIRLIK:2,551 kg/mt

jx:21,012 cm⁴

yy:137,768 cm⁴

Kasa Profili

1,913 kg/mt

jx:44,000 cm⁴

yy:27,440 cm⁴

Kanat Profili

1,748 kg/mt

jx:42,357

yy:26,368

Sabit Kanat Profili

SİSTEM NUMARASI

126 HB 1357-1358

126 HB 1350-1365-1350

KALIP NUMARASI

1357-1358

1350-1365-1350

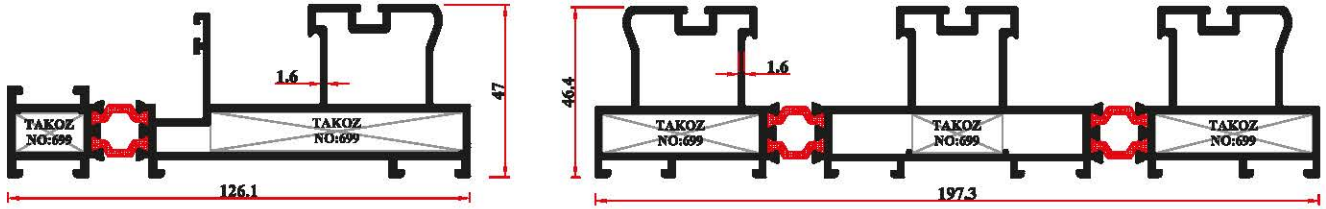

AĞIRLIK:2,312 kg/mt

jx:12,914 cm⁴

yy:128,858 cm⁴

Sabitli Kasa Profili

3,988 kg/mt

jx:71,625 cm⁴

yy:563,912 cm⁴

3'lü Kasa Profili

SİSTEM NUMARASI

126 HB 1357-1364

126 HB 1355

126 HB 1362-1363

126 HB 994

KALIP NUMARASI

1357-1364

1355

1362-1363

994

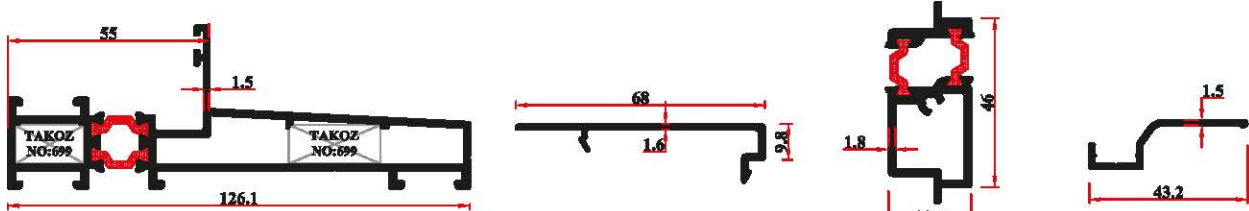

AĞIRLIK:1,813 kg/mt

jx:128,868 cm⁴

yy:12,910 cm⁴

Pervazlı Sabit Kasa Profili

0,397 kg/mt

Kenet Profili

0,927 kg/mt

Adaptör Profili

0,235 kg/mt

Damlalık Profili

SİSTEM NUMARASI

126 HB 1359

126 HB 1354

126 HB 375

126 HB 8168

KALIP NUMARASI

1359

1354

375

8168

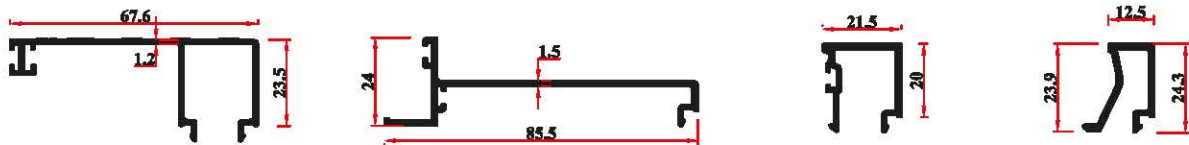

AĞIRLIK:0,510 kg/mt

Sabit Kanat Çıtası Profili

0,521 kg/mt

Kapak Profili

0,294 kg/mt

Kanat Çıta Profili

0,275 kg/mt

Çıta Profili

HB 126



ARWIS KALDIR-SÜR SİSTEM SERİSİ ARWIS LIFT AND SLIDE SYSTEM SERIES

SİSTEM NUMARASI

126 HB 452-453

126 HB 452-457

126 HB 464-465

126 HB 486-487

KALIP NUMARASI

452-453

452-457

464-465

486-487

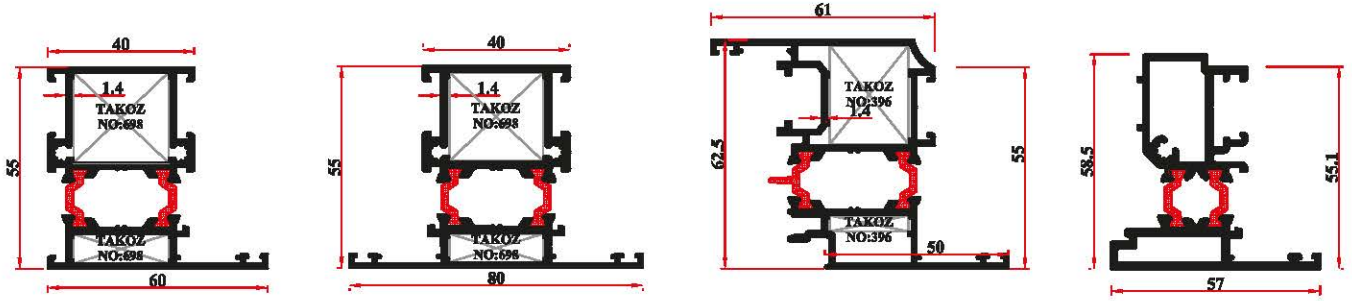

AĞIRLIK:1,380 kg/mt

1,494 kg/mt

1,610 kg/mt

1,397 kg/mt

jx:10,9895

jx:18,159

jx:12,718

iy:17,8293

iy:16,306

iy:30,227

40'lık Düz Kasa Profili

40'lık Orta Kayıt Profili

61'lık PVC Kanat Profili (1.4 mm)

Çift Açılır Kanat Adaptörü

SİSTEM NUMARASI

126 HB 698

126 HB 396

126 HB 699

126 HB 397

KALIP NUMARASI

698

396

699

397

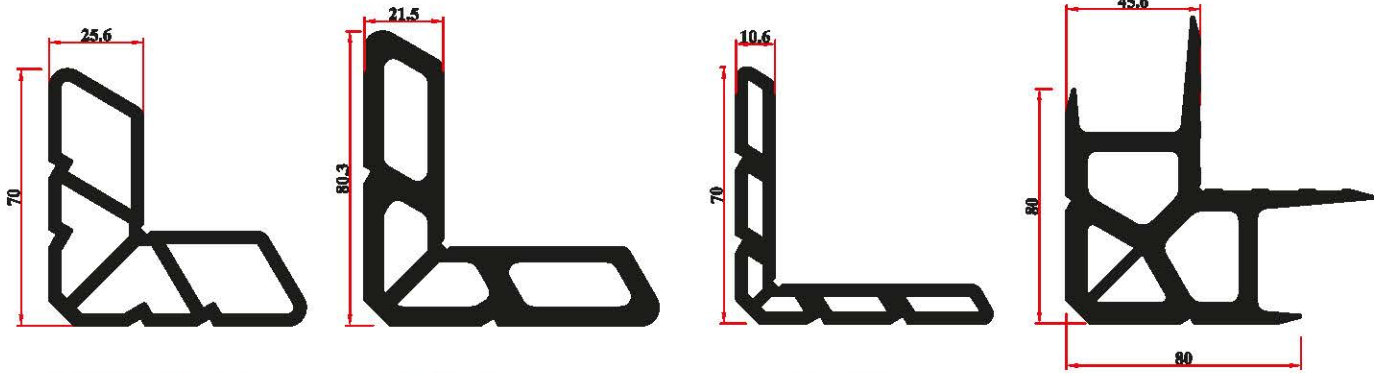

AĞIRLIK:2,630 kg/mt

4,339 kg/mt

2,392 kg/mt

6,658 kg/mt

Orta Seri Takoz

2 mm Dar Seri Takozu

Kasa Takoz Profili

2 mm Geniş Seri Takozu

KULLANILAN PROFİL NO	KULLANILAN PROFİL NO	KÖŞE TAKOZ KALIB NO	KÖŞE TAKOZ PROFİL NO	KESİM ÖLÇÜSÜ (L)	KÖŞE TAKOZ KESİM NO	AKSESUAR NO
126 HB 1350-1351	126 HB 1350	699	126 HB 699	48,8 MM	TK-699-48,8	-
126 HB 1352-1353	126 HB 1351	699	126 HB 699	43 MM	TK-699-43	-
126 HB 1357-1358	126 HB 1352	397	126 HB 397	12 MM	TK-397-12	-
126 HB 1360-1361	126 HB 1353	397	126 HB 397	12 MM	TK-397-12	-
126 HB 1364-1365	126 HB 1357	699	126 HB 699	18,9 MM	TK-699-18,9	-
126 HB 1366-1367	126 HB 1358	699	126 HB 699	69 MM	TK-699-69	-
126 HB 1368-1369	126 HB 1360	397	126 HB 397	27,6 MM	TK-397-27,6	-
126 HB 1370-1371	126 HB 1361	397	126 HB 397	4,9 MM	TK-397-4,9	-
126 HB 452-453	126 HB 452	698	126 HB 698	24,2 MM	TK-698-24,2	-
126 HB 452-457	126 HB 453	698	126 HB 698	5 MM	TK-698-5	-
126 HB 464-465	126 HB 452	698	126 HB 698	24,2 MM	TK-698-24,2	-
126 HB 486-487	126 HB 457	698	126 HB 698	7,8 MM	TK-698-7,8	-
126 HB 1365-1366	126 HB 464	396	126 HB 396	26,9 MM	TK-396-26,9	-
126 HB 1367-1368	126 HB 465	396	126 HB 396	4,3 MM	TK-396-4,3	-
126 HB 1369-1370	126 HB 1350	699	126 HB 699	43 MM	TK-699-43	-
126 HB 1371-1372	126 HB 1365	699	126 HB 699	43 MM	TK-699-43	-
126 HB 1373-1374	126 HB 1350	699	126 HB 699	43 MM	TK-699-43	-
126 HB 1375-1376	126 HB 1357	699	126 HB 699	18,9 MM	TK-699-18,9	-
126 HB 1377-1378	126 HB 1364	699	126 HB 699	24,4 MM	TK-699-24,4	-

PROFİLLERİN BİRİM AĞIRLIKLARI TEORİK OLARAK HESAPLANMIŞTIR / PROFILES UNIT WEIGHTS CALCULATED THEORETICALLY

AKSESUAR KODU	AKSESUAR RESMİ	KULLANILDIĞI YER	AKSESUAR KODU	AKSESUAR RESMİ	KULLANILDIĞI YER
126 HB F56 İÇ CAM FİTİLİ 1 Kollide 12 kg/290 m			126 HB F51 İÇ CAM FİTİLİ 1 Kollide 12 kg/280 m		
126 HB F55 KENET FİTİLİ 1 Kollide 6 kg/125 m			126 HB F57 KASA KAPAMA FİTİLİ 1 Kollide 12 kg/270 m		
126 HB F54 KANAT FİTİLİ 1 Kollide 5 kg/125 m			126 HB A01-1 Kaldir Sür Aksesuarı 200 kg İnk Anaba		
126 HB A01 Kaldir Sür Aksesuarı 300 kg İnk Anaba			126 HB A02 KİL FİTİL (69-700)		
126 HB A06 SABİT ÇITA PLASTİĞİ 1 BOY 6 M			126 HB A03 RAY ARASI KAFAMA 1 BOY 6 M		
126 HB A06 U Ray			126 HB A29-1 YARIM KAPAMA PROFİLİ 1 BOY 6 M		
126 HB A11 TEKRAR ALTI PLASTİĞİ 1 Paket 12 Adet			126 HB A29 KENET PROFİLİ 1 BOY 6 M		
126 HB A30 KENET KAPAĞI 1 Paket 30 Adet			126 HB A07 Tabliye Teğmen		
126 HB A32 SİKİŞTİRMA PROFİLİ 1 BOY 6 M			126 HB A26 Tezduk A03 İpin 1 Paket 100 Adet		
126 HB A31 ADAPTÖR PROFİLİ KAPAĞI			126 HB A28-1 Tezduk A29-1 İpin 1 Paket 100 Adet		
126 HB A15 KOŞE ÇAVUŞU			126 HB A15 KOŞE ÇAVUŞU		

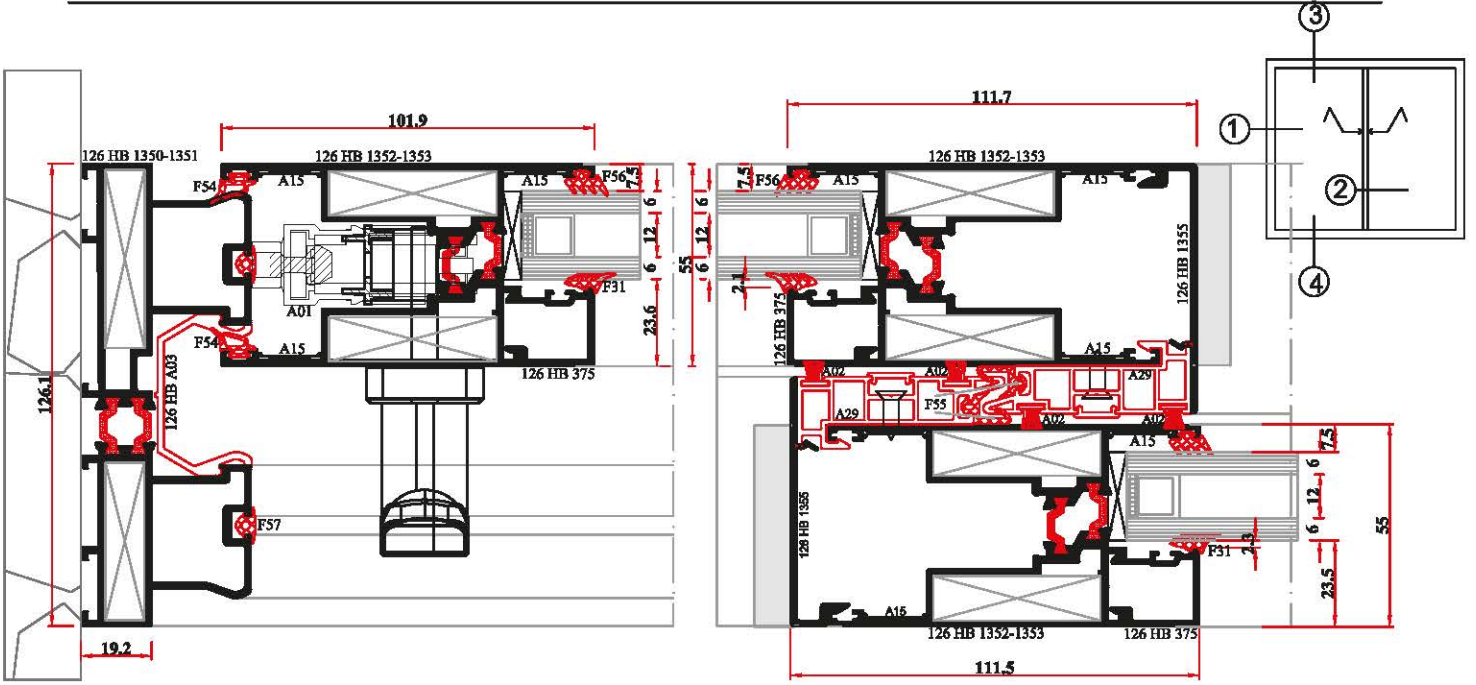

1 NOLU DETAY

2 NOLU DETAY

ÖLÇEK:1/2

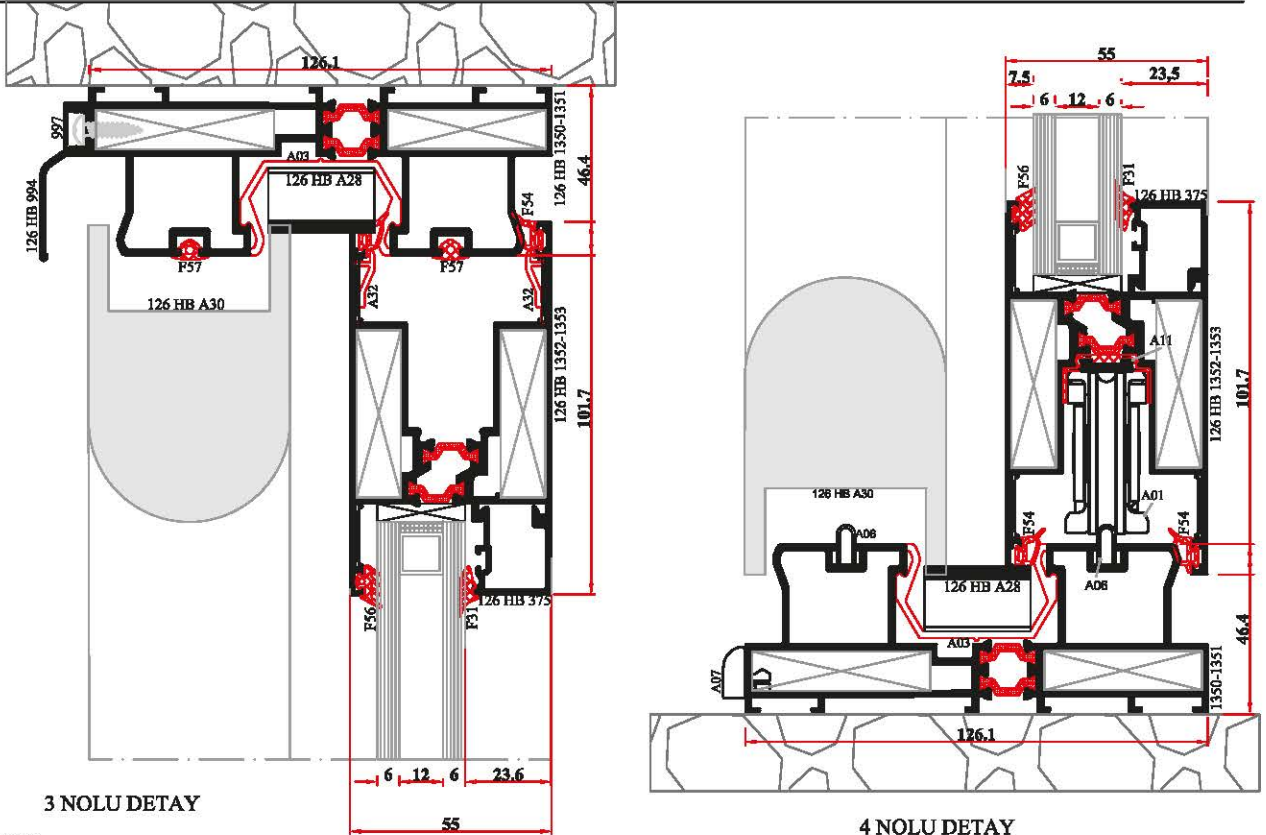

3 NOLU DETAY

4 NOLU DETAY

ÖLÇEK:1/2

ÖLÇEK:1/2

SİSTEM DETAYLARI / SYSTEM DETAILS

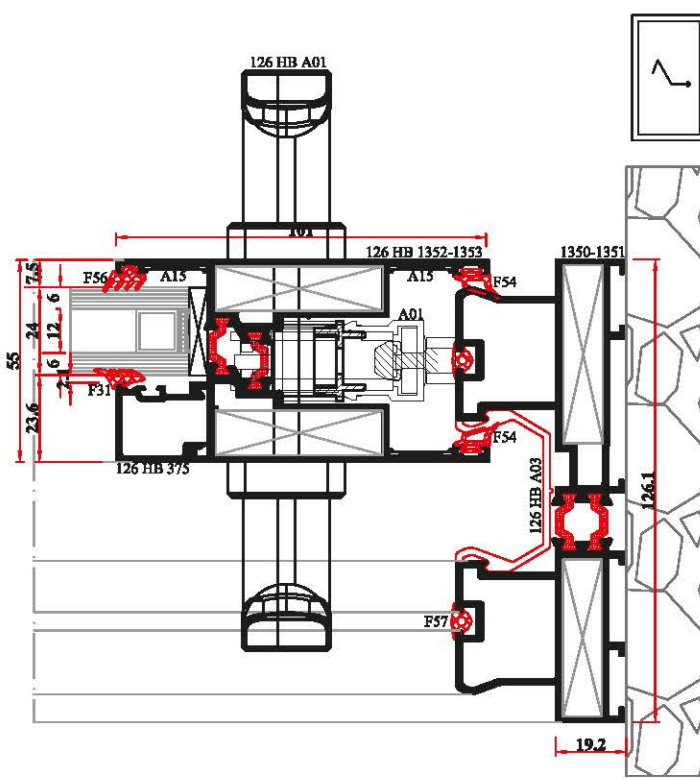

1 NOLU DETAY

ÖLÇEK:1/2

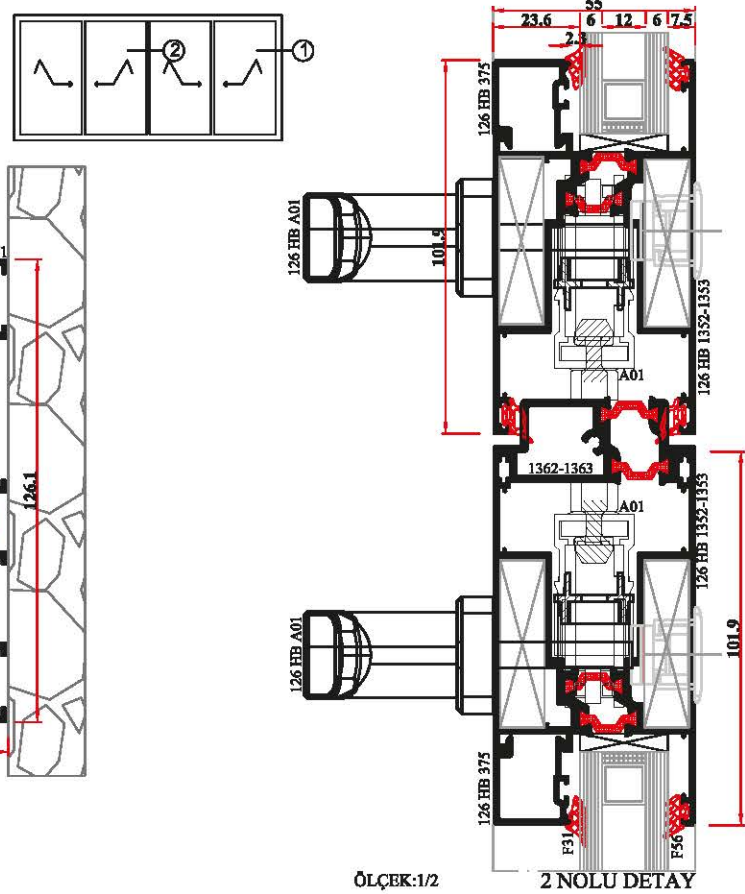

2 NOLU DETAY

ÖLÇEK:1/2

SİSTEM DETAYLARI / SYSTEM DETAILS

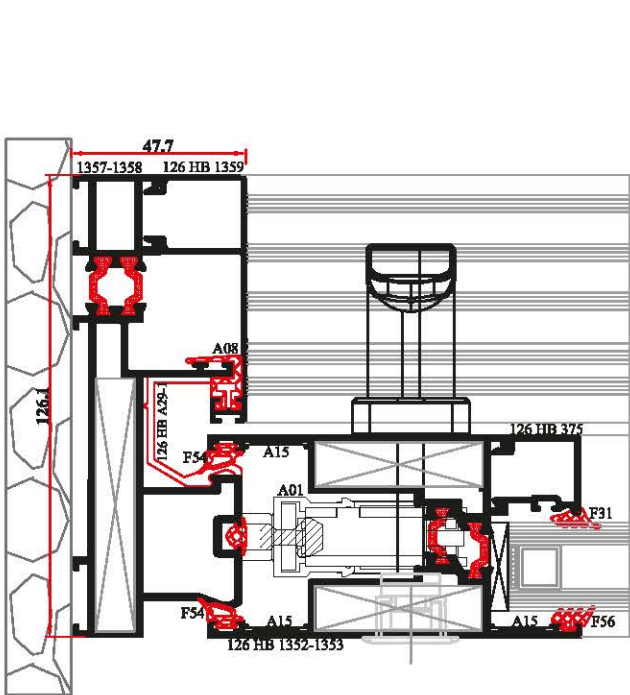

1 NOLU DETAY

ÖLÇEK:1/2

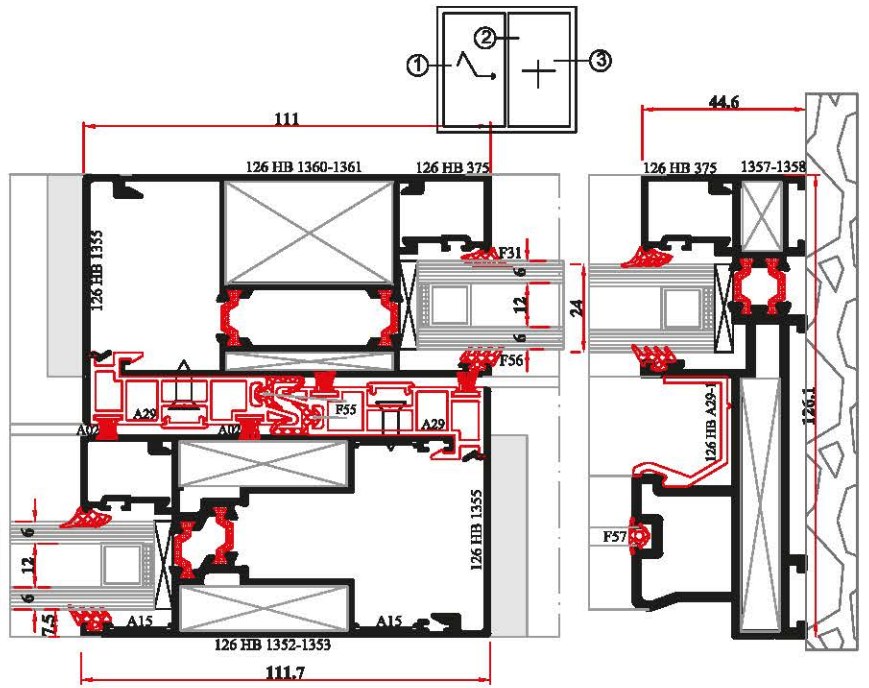

2 NOLU DETAY

3 NOLU DETAY

ÖLÇEK:1/2

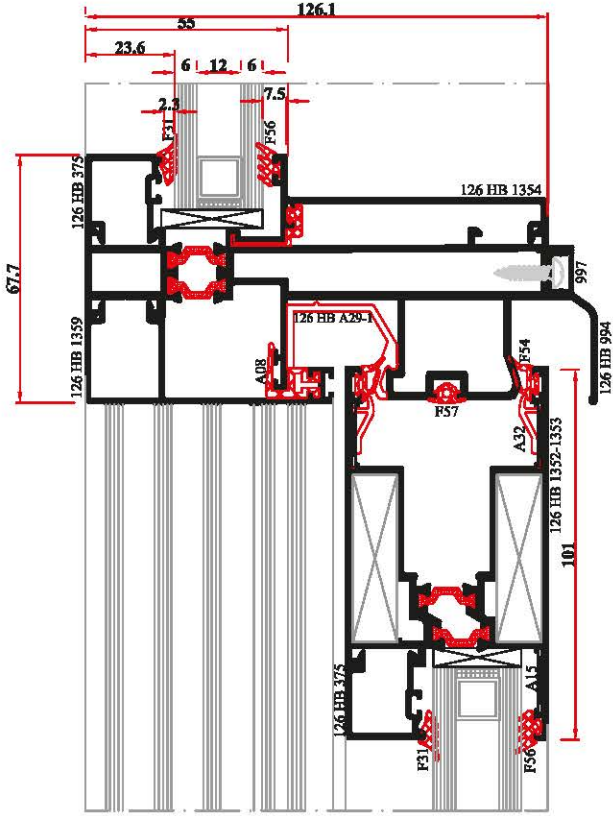

1 NOLU DETAY

ÖLÇEK:1/2

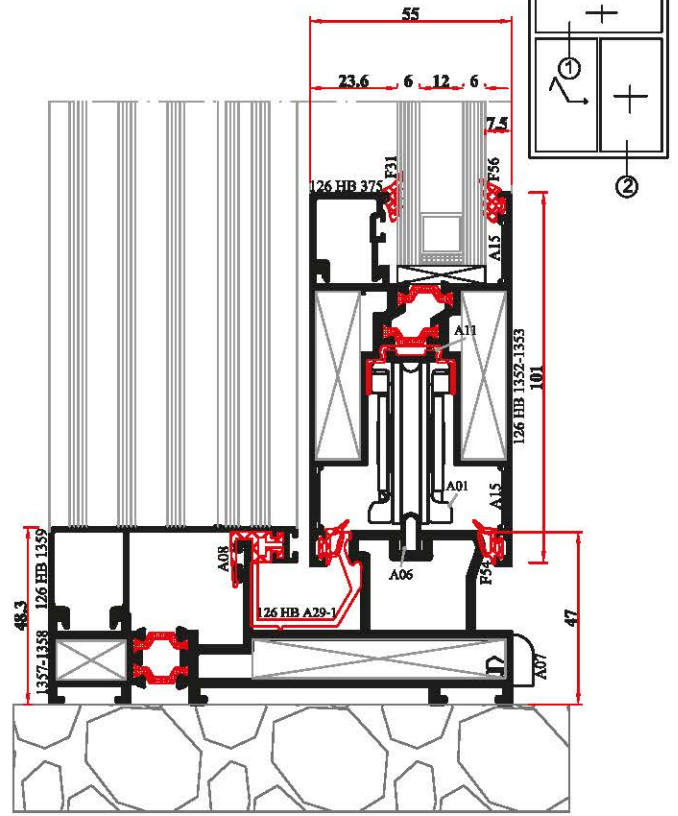

2 NOLU DETAY

ÖLÇEK:1/2

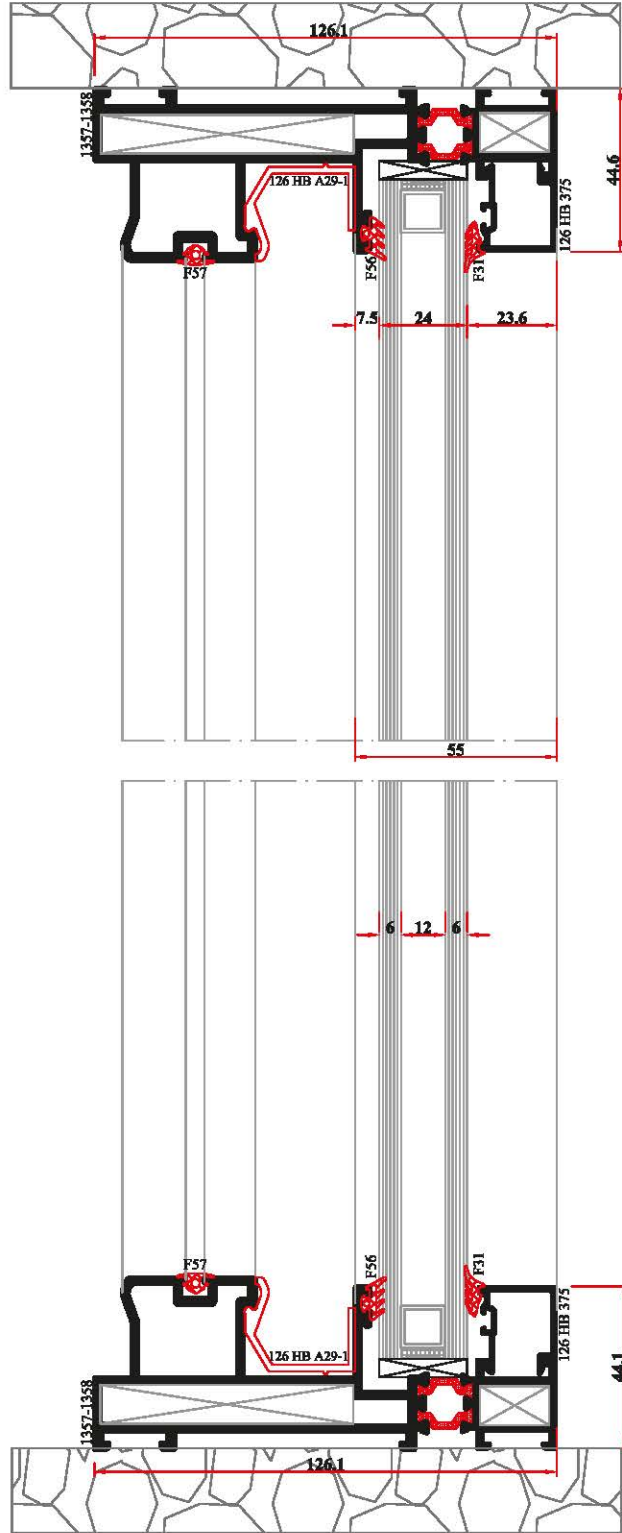
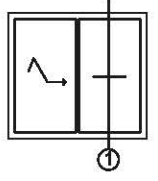

1 NOLU DETAY

ÖLÇEK:1/2

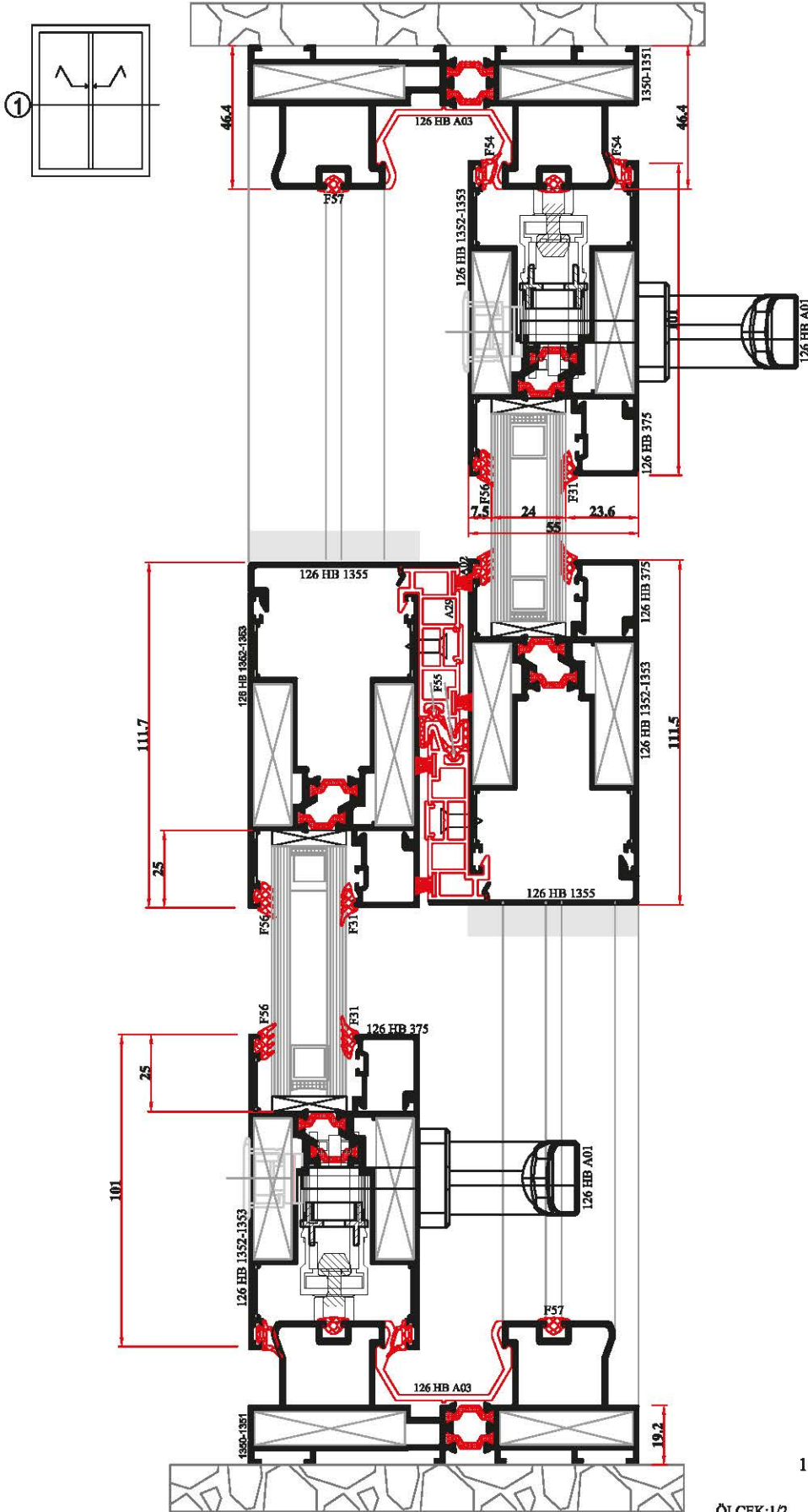

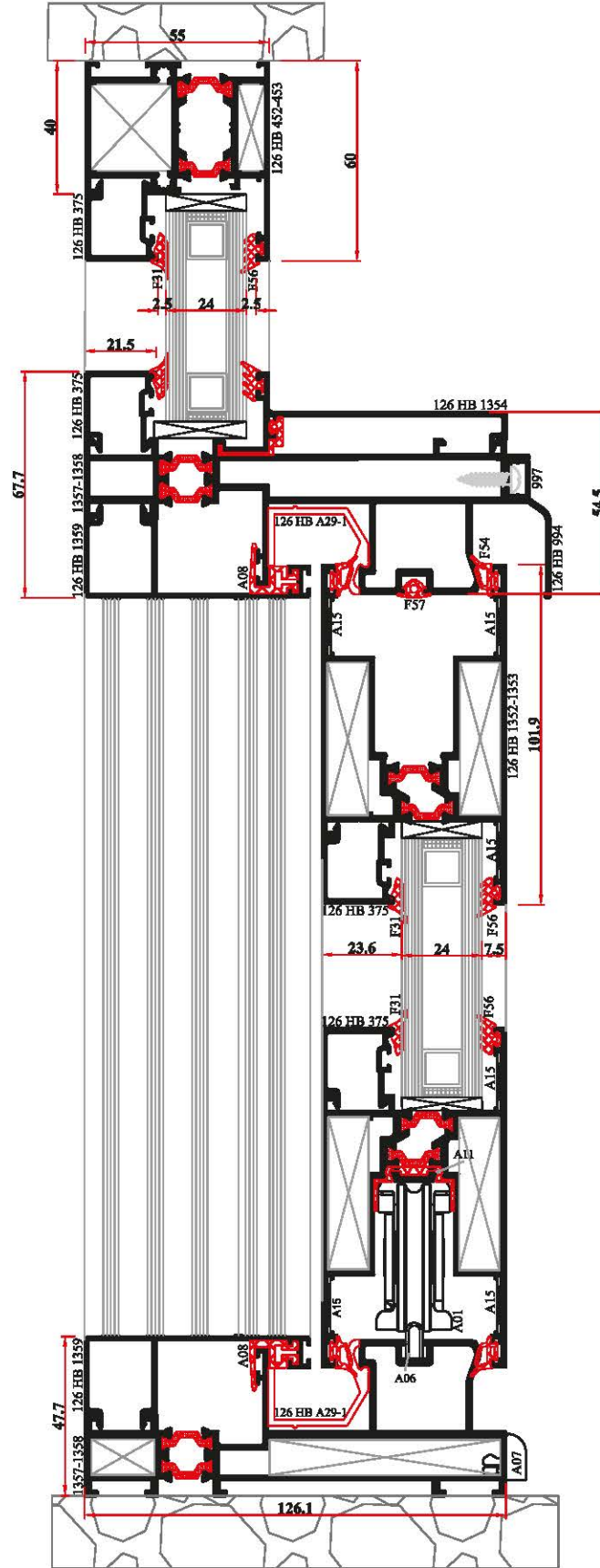

1 NOLU DETAY

ÖLÇEK:1/2

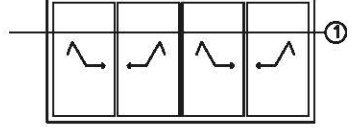
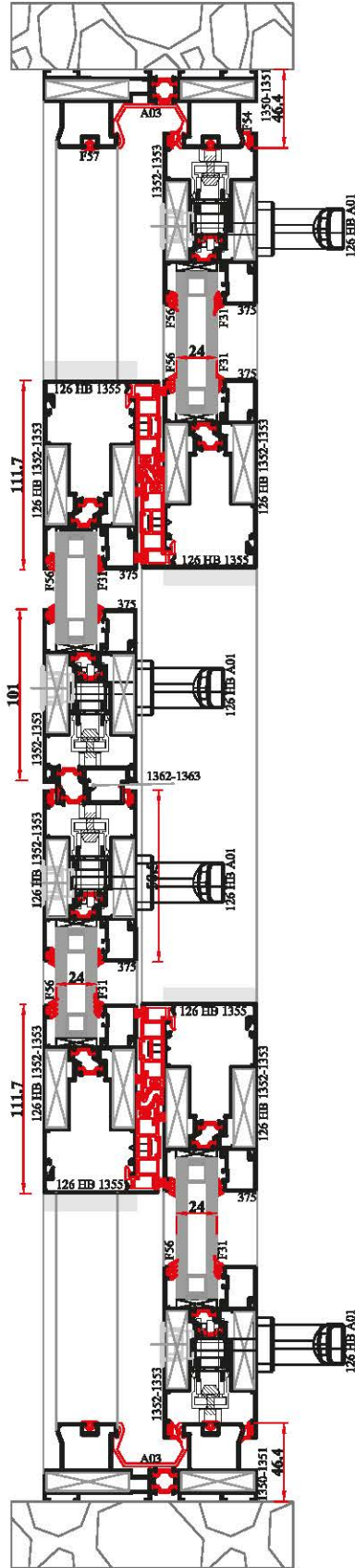

1 NOLU DETAY

ÖLÇEK:1/4