



ULUSAN[®]
aluminium profiles technology

MİNİNERVA CAMLAMA SİSTEM SERİSİ

AG 40





AG40

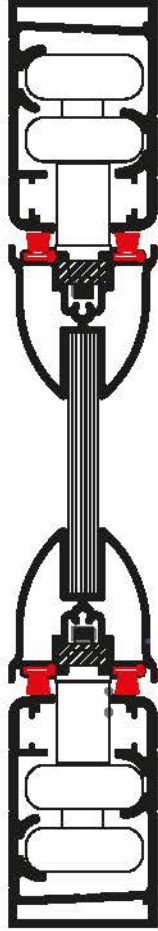

TEKNİK ÖZELLİKLER / TECHNICAL PROPERTIES

KASA DERİNLİĞİ / FRAME DEPTH	40mm
KANAT DERİNLİĞİ / VENT DEPTH	40mm
PROFİL ET KALINLIĞI / PROFILE WALL THCKNESS	1.3 / 1.8 / 2 / 2.3mm
CAM KALINLIĞI / GLASS THCKNESS	8-10mm

SİSTEM NUMARASI

40 AG 3900

40 AG 3901

40 AG 3973

40 AG 3974

KALIP NUMARASI

3900

3901

3973

3974

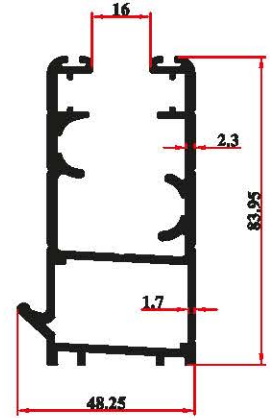
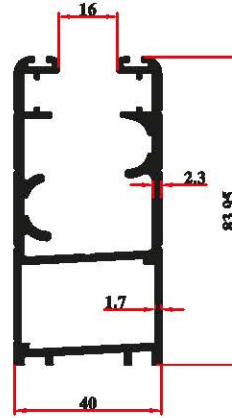
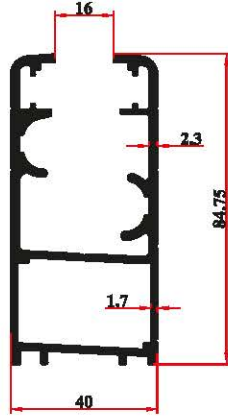
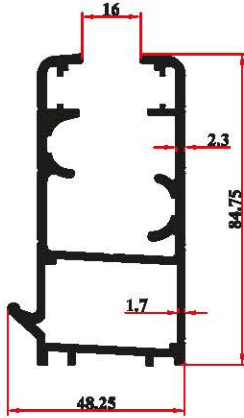
**AĞIRLIK: 1,824 kg/mt****1,746 kg/mt****1,723 kg/mt****1,799 kg/mt**jx:18,704 cm⁴jx:17,105 cm⁴jx:17,178 cm⁴jx:18,769 cm⁴jy:45,735 cm⁴jy:43,422 cm⁴jy:42,493 cm⁴jy:44,750 cm⁴

Fitsiz Kasa Profili(Damlahlık)

Kasa Profili

Fıtlı Kasa Profili

Fıtlı Kasa Profili(Damlahlık)

SİSTEM NUMARASI

40 AG 1339

40 AG 1340

40 AG 5087

40 AG 5088

KALIP NUMARASI

1339

1340

5087

5088

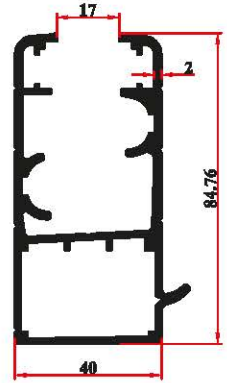
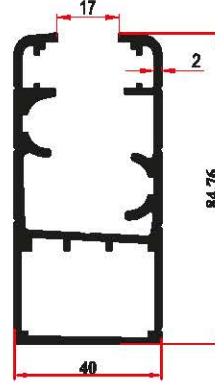
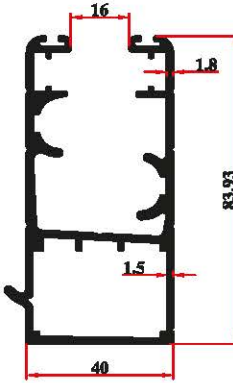
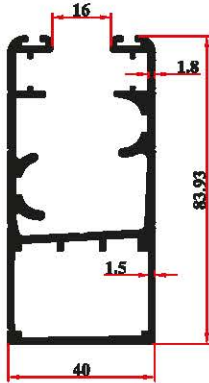
**AĞIRLIK: 1,652 kg/mt****1,690 kg/mt****1,690 kg/mt****1,742 kg/mt**jx:18,610 cm⁴jx:19,09 cm⁴jx:16,63 cm⁴jx:17,68 cm⁴jy:41,660 cm⁴jy:41,726 cm⁴jy:42,119 cm⁴jy:43,629 cm⁴

Kasa Profili

Kasa Profili

Kasa Profili

Kasa Profili

SİSTEM NUMARASI

40 AG 1337

40 AG 3761

40 AG 3762

40 AG 3763

KALIP NUMARASI

1337

3761

3762

3763

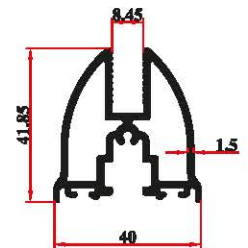
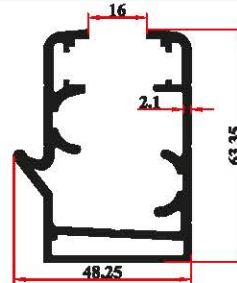
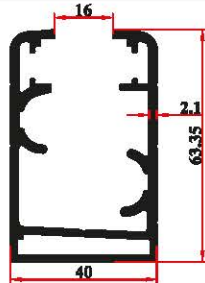
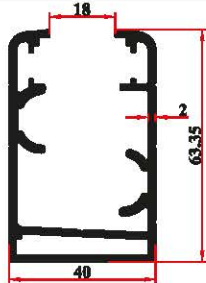
**AĞIRLIK:1,380 kg/mt****1,460 kg/mt****1,520 kg/mt****0,916 kg/mt**jx:13,058 cm⁴jx:15,400 cm⁴jx:13,779 cm⁴jx:4,351 cm⁴jy:21,914 cm⁴jy:22,920 cm⁴jy:23,322 cm⁴jy:5,016 cm⁴

Kasa Profili

Kasa Profili

Kasa Profili (Damlahlık)

Kanat Profili

SİSTEM NUMARASI		40 AG 3764		40 AG 3876		40 AG 3788	
40 AG 3899	40 AG 1338						
KALIP NUMARASI		3764		3876		3788	
3899	1338						

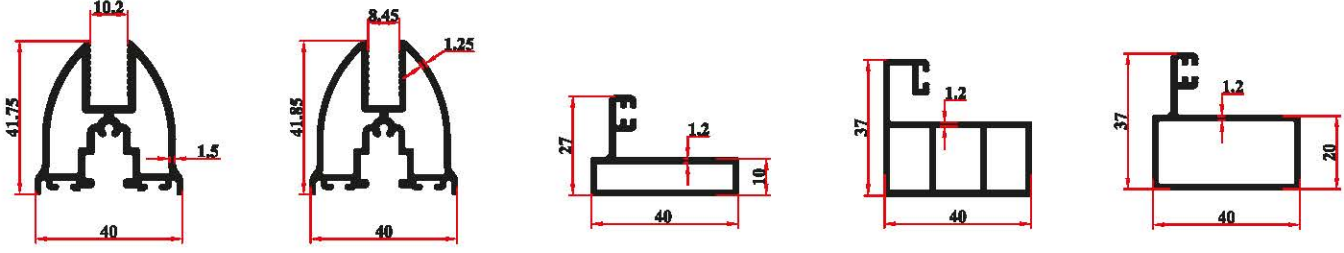

AĞIRLIK:0,929 kg/mt	0,802 kg/mt	0,435 kg/mt	0,623 kg/mt	0,498 kg/mt
jx:4,429 cm ⁴	jx:4,351 cm ⁴	jx:2,727 cm ⁴	jx:4,840 cm ⁴	jx:3,9363 cm ⁴
iy:4,899 cm ⁴	iy:5,016 cm ⁴	iy:0,829 cm ⁴	iy:2,178 cm ⁴	iy:1,9609 cm ⁴
Kanat Profili	Kanat Profili	Yan dikme profili	Yan dikme profili	Yan dikme profili

SİSTEM NUMARASI					
40 AG 3775	40 AG 3776	40 AG 3807	40 AG 3808	40 AG 3766	40 AG 3983
KALIP NUMARASI					
3775	3776	3807	3808	3766	3983

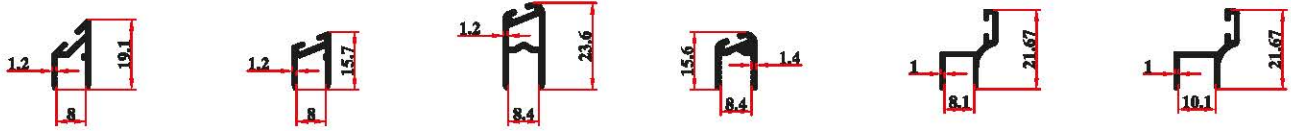

AĞIRLIK:0,141 kg/mt	0,126 kg/mt	0,224 kg/mt	0,165 kg/mt	0,140 kg/mt	0,146 kg/mt
----------------------------	--------------------	--------------------	--------------------	--------------------	--------------------

SİSTEM NUMARASI					
40 AG 3984	40 AG 3985	40 AG 3902	40 AG 3878	40 AG 3877	
KALIP NUMARASI					
3984	3985	3902	3878	3877	

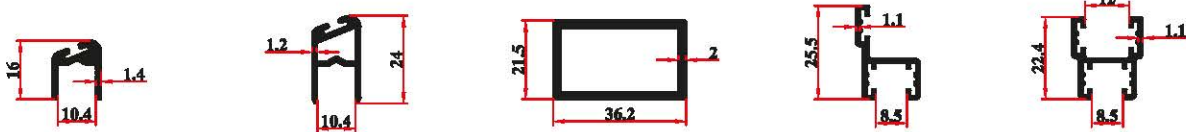

AĞIRLIK:0,192 kg/mt	0,254 kg/mt	0,580 kg/mt	0,213 kg/mt	0,260 kg/mt
----------------------------	--------------------	--------------------	--------------------	--------------------

SİSTEM NUMARASI				
40 AG 1336	40 AG 4020	40 AG 3765	40 AG 3982	
KALIP NUMARASI				
1336	4020	5089	3765	3982

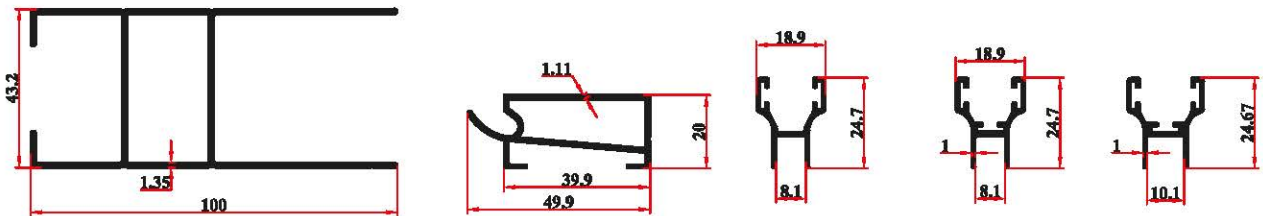

AĞIRLIK:1,096 kg/mt	0,486 kg/mt	0,213 kg/mt	0,226 kg/mt	0,246 kg/mt
jx:13,949 cm ⁴	jx:4,2860cm ⁴			
iy:29,969 cm ⁴	iy:0,7524cm ⁴			
Ayarlı kasa profili	Damlahlıklı Kasa Profili			

AG 40



MİNERVA CAMLAMA GOLD SERİSİ MINERVA GLAZING GOLD SERIES

SİSTEM NUMARASI

40 AG 6320

40 AG 6319

KALIP NUMARASI

6320

6319

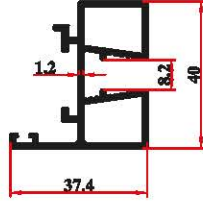
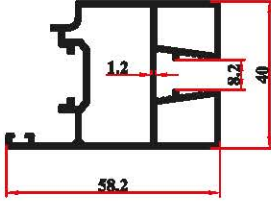

AĞIRLIK: 0,883 kg/mt

jx:37,840 cm⁴



jy:32,823 cm⁴





0,610 kg/mt

jx:18,113 cm⁴

jy:4,203 cm⁴

PROFİLLERİN BİRİM AĞIRLIKLARI TEORİK OLARAK HESAPLANMIŞTIR / PROFILES UNIT WEIGHTS CALCULATED THEORETICALLY

AKSESUAR KODU	AKSESUAR RESMİ	AKSESUAR KODU	AKSESUAR RESMİ
GLD 401 Zamak Düz Teker		GLD 411 135° Baza Kapağı	
GLD 402 Zamak Parklı Teker		GLD 412 Oval Baza Kapağı	
GLD 403 Plastik Teker Düz		GLD 413 Deve Boynu	
GLD 404 Plastik Teker Parklı		GLD 414 1'li Park	
GLD 405 Alt Üst Pim Mentеше		GLD 415 3'lü Park	
GLD 406 Kilit Takımı		GLD 416 5'li Park	
GLD 407 Teker Çıkış Yuvası		GLD 417 7'li Park	
GLD 408 Köşe Bitim Kapağı		GLD 418 9'lu Park	
GLD 409 Düz Baza Kapağı		GLD 419 Park Sabitleme	
GLD 410 90° Baza Kapağı		GLD 420 Teker Çıkış Kapağı	

AKSESUAR KODU	AKSESUAR RESMİ	AKSESUAR KODU	AKSESUAR RESMİ
GLD 421 Kasa Birleştirme Takoza		GLD 422 Kasa Birleştirme Takoza	
GLD 423 Kanat Stoplama Stoper		GLD 424 Cam Armut Tutucu Klips	
GLD 425 Boncuklu İp		GLD 44 Kanat Kıl Fıtıl(800)	
GLD 45 Kanat Kıl Fıtıl(1200)		GLD 46 Kanat Kıl Fıtıl(1500)	
GLD 47 Sürme Kıl Fıtıl 67-550		UBC-01 P.U. Mastik	
UBC-31 Yeşil Bant Cam Montaj Bandı			

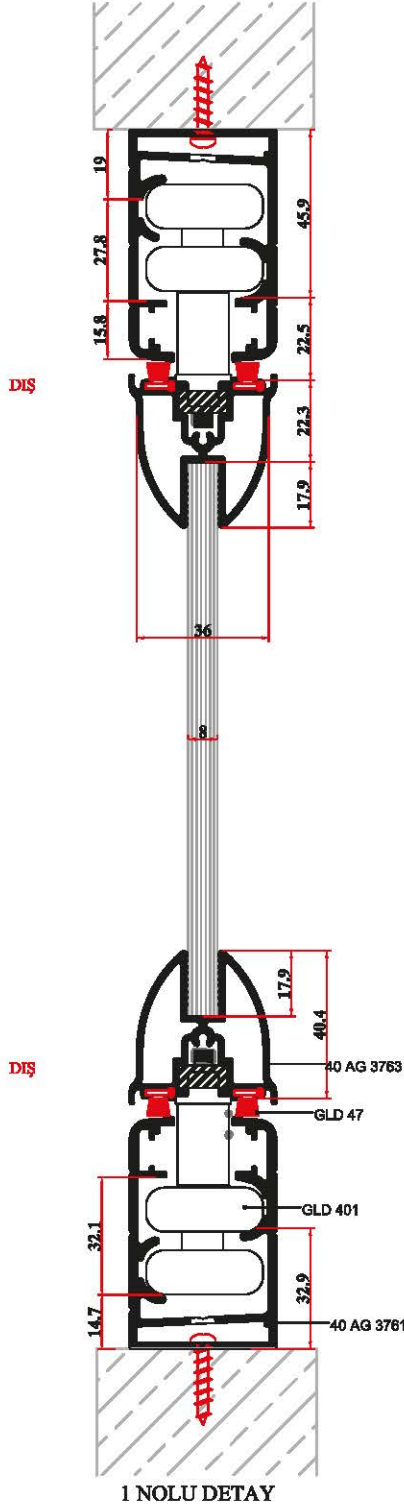
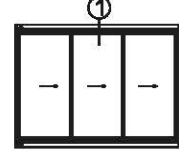

TEKER RAY KASISINDA CAM BOYUNUN HESAPLANMASI

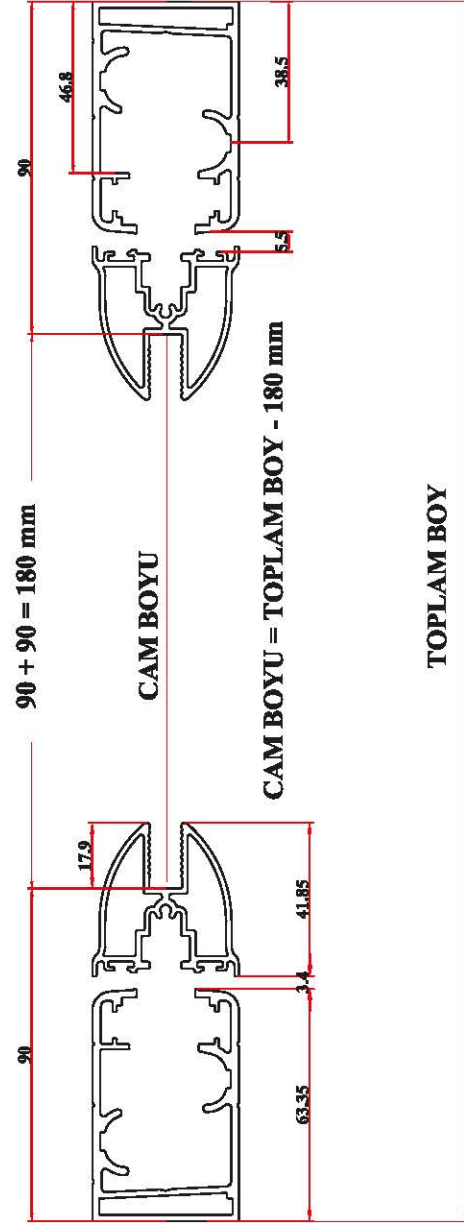

SİSTEM NUMARASI

40 AG 2140

40 AG 2130

40 AG 2145

KALIP NUMARASI

2140

2130

2145

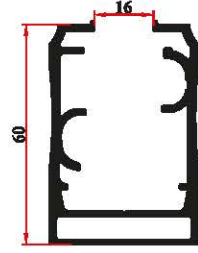
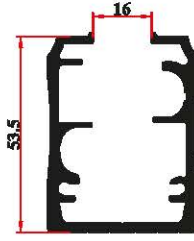
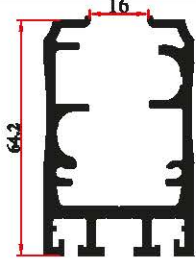
**AĞIRLIK: 1,717 kg/mt****1,314 kg/mt****1,363 kg/mt**

jx:15,7796

jx:12,8379

jx:13,4318

jy:25,0813

jy:15,7044

jy:19,6261

64,2' lik Düz Kasa Profili

53,5' lik Düz Kasa Profili

60'lik Düz Kasa Profili

SİSTEM NUMARASI

40 AG 2143

40 AG 2138

40 AG 2135

KALIP NUMARASI

2143

2138

2135

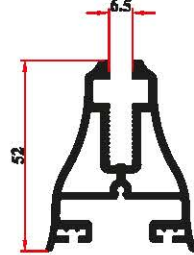
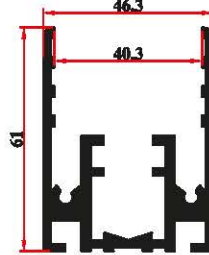
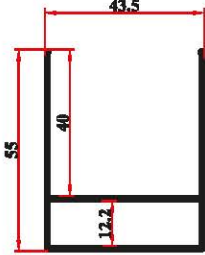
**AĞIRLIK:0,680 kg/mt****1,785 kg/mt****1,118 kg/mt**

jx:7,746

jx:17,1412

jx:4,9794

jy:6,507

jy:19,5197

jy:8,7183

Ayar Kasa Profili

Ayar Kasa Profili

6,5'lik Kanat Profili

SİSTEM NUMARASI

40 AG 2134

40 AG 2131

40 AG 2141

KALIP NUMARASI

2134

2131

2141

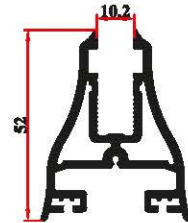
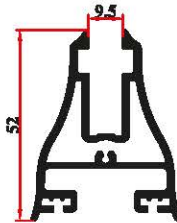
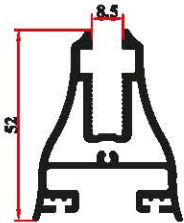
**AĞIRLIK: 1,069 kg/mt****1,029 kg/mt****1,131 kg/mt**

jx:5,0234

jx:4,992

jx:5,3846

jy:7,9970

jy:7,563

jy:7,4163

8,5'lik Kanat Profili

9,5'lik Kanat Profili

10,2'lik Kanat Profili

SİSTEM NUMARASI

40 AG 2144

40 AG 2132

40 AG 2133

40 AG 382

40 AG 3980

40 AG 2139

KALIP NUMARASI

2144

2132

2133

382

3980

2139

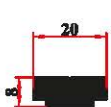
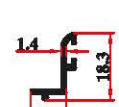
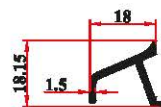
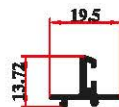
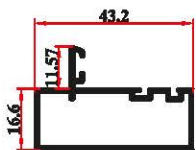
**AĞIRLIK:0,445 kg/mt****0,478 kg/mt****0,132 kg/mt****0,170 kg/mt****0,119 kg/mt****0,394 kg/mt**

jx:1,0409

jx:3,661

jy:3,3981

jy:0,702





















Yan Dikme Kutusu

Yan Dikme Kutusu

Cam Çıtası (20,3 mm)

Damlalık Profili

Somun Profili

AKSESUAR KODU	AKSESUAR RESMİ	AKSESUAR KODU	AKSESUAR RESMİ
UBC 005 Normal Teker (Krom)		UBC 34 Kanat Tutamağı	
UBC 006 Yarıklı Teker (Krom)		UBC 102 Lüks Kilit Takımı	
UBC 103 Gizli Klavuz (Krom)		UBC 100 Teker Çıkış (Alt)	
UBC 205 Normal Teker (Pvc)		UBC 101 Teker Çıkış (Üst)	
UBC 206 Yarıklı Teker (Pvc)		UBC 104 Kilit Kapağı (Alt)	
UBC 203 Gizli Klavuz (Pvc)		UBC 105 Kilit Kapağı (Üst)	
UBC 07 Menteşe Takımı		UBC 111 Orta Alın Kapağı (Sol)	
UBC 107 Alüminyum Stoper		UBC 112 Orta Alın Kapağı (Sağ)	
UBC 108 Kasa Ayar Vidası		UBC 113 Çarpma Alın Kapağı	
UBC 106 Klavuz Pimi		UBC 114 Çarpma Kanat Alın Karşılığı	

AKSESUAR KODU	AKSESUAR RESMİ	AKSESUAR KODU	AKSESUAR RESMİ
UBC 115 Çarpma Alın Kapağı		UBC 123 22.5° Serbet Dönüş Kapağı (Sol)	
UBC 116 Çarpma Kanat Alın Karşılığı		UBC 124 22.5° Serbet Dönüş Kapağı (Sağ)	
UBC 117 Menteşe Kanat Alın Kapağı		UBC 125 Bitiş Alın Kapağı	
UBC 118 Menteşe Kanat Alın Kapağı		UBC 026 Stoper Dayama	
UBC 119 90 ° Dönüş Kapağı (Sol)		UBC 035 Yan Dikme Plastiği	
UBC 120 90 ° Dönüş Kapağı (Sağ)		UBC 008 Zincirli Kilit Takımı	
UBC 121 45 ° Dönüş Kapağı (Sol)		UBC 009 Katlanır Klavuz	
UBC 122 45 ° Dönüş Kapağı (Sağ)		UBC 126 Ayarlanabilir Köşe Çavuşu	

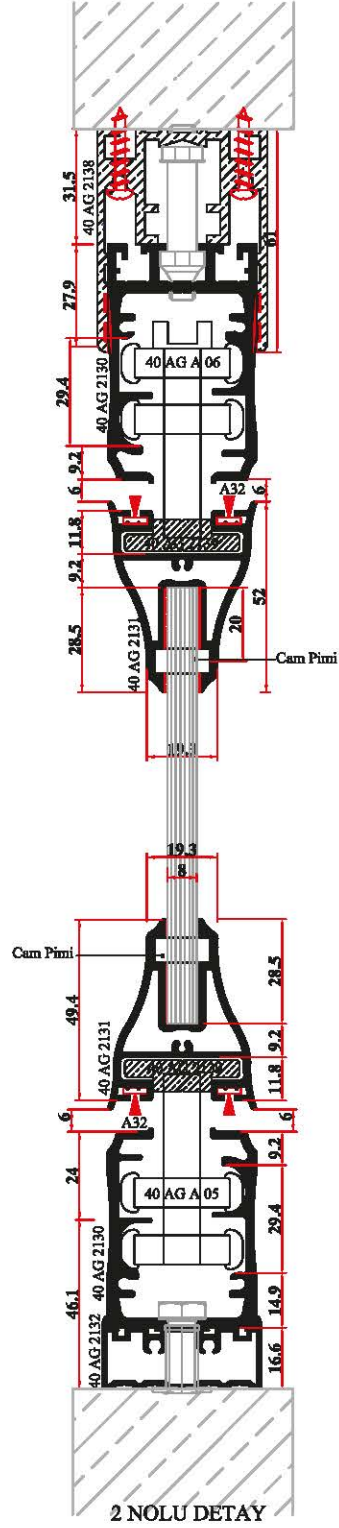
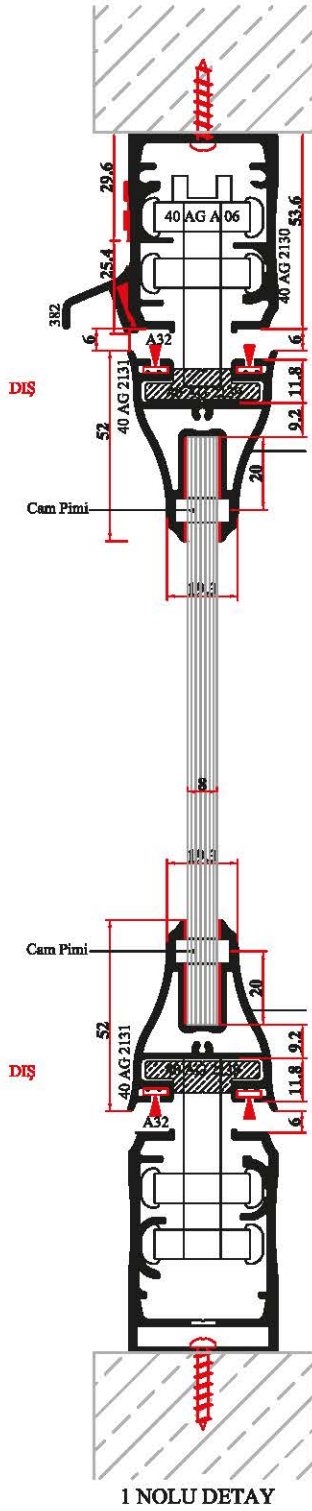
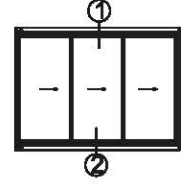

AG 40



MİNİNERVA CAMLAMA SİSTEM SERİSİ MINİNERVA GLAZING SYSTEM SERIES

SİSTEM DETAYLARI / SYSTEM DETAILS

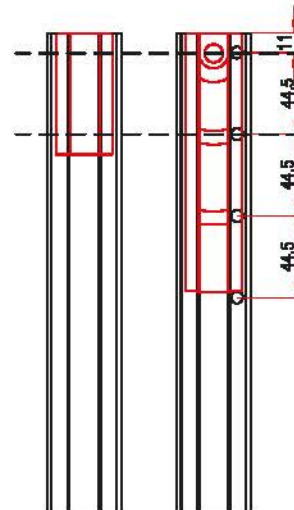
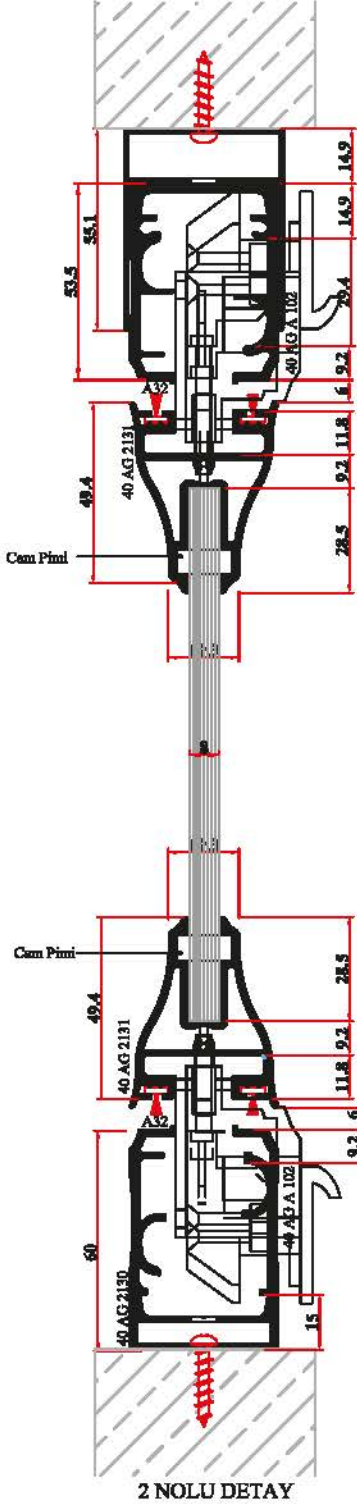
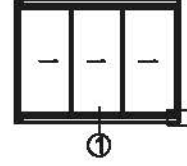

ÖLÇEK:1/2

ÖLÇEK:1/4

TAKVİYELİ TEKER RAY KASISINDA CAM BOYUNUN HESAPLANMASI

