

# ARWIS YALITIMSIZ SÜRME SERİSİ

SGS 95





# SGS95

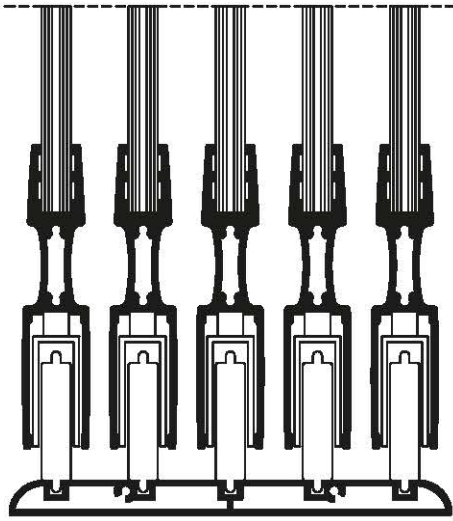

## TEKNİK ÖZELLİKLER / TECHNICAL PROPERTIES

**KASA DERİNLİĞİ / FRAME DEPTH**

120mm

**KANAT DERİNLİĞİ / VENT DEPTH**

18mm

**PROFİL ET KALINLIĞI / PROFILE WALL THCKNESS**

1.3 / 1.5mm

**CAM KALINLIĞI / GLASS THCKNESS**

8-10mm

**EŞİKLİ VE EŞİKSİZ ALT RAY PROFİLLERİ / THRESHOLD AND NON - THRESHOLD BOTTOM RAIN PROFILES**

**MAKSİMUM KANAT GENİŞLİĞİ 1000MM / MAX. 1000MM SASH WIDHT**

**MAKSİMUM KANAT YÜKSEKLİĞİ 3000MM / MAX. 3000MM SASH HEIGHT**

### SİSTEM NUMARASI

95 SGS 1370

95 SGS 1385

95 SGS 1384

### KALIP NUMARASI

1370

1385

1384

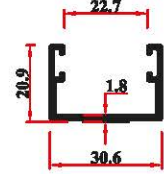
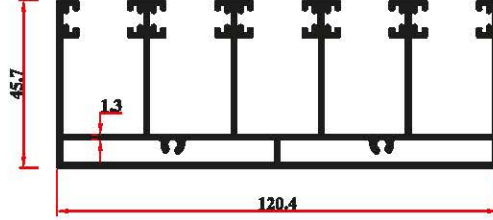
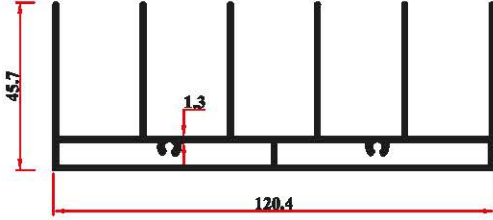

**AĞIRLIK:1,771 kg/mt**

jx:95,947 cm<sup>4</sup>

jy:12,078 cm<sup>4</sup>

Üst Ray

**2,327 kg/mt**

jx:120,866 cm<sup>4</sup>

jy:22,934 cm<sup>4</sup>

Üst Ray(Fitilli)

**0,311 kg/mt**

jx:1,683 cm<sup>4</sup>

jy:0,562 cm<sup>4</sup>

Yan Dikme U(Geniş)

### SİSTEM NUMARASI

95 SGS 1372

95 SGS 1371

95 SGS 1382

### KALIP NUMARASI

1372

1371

1382

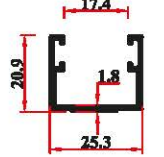
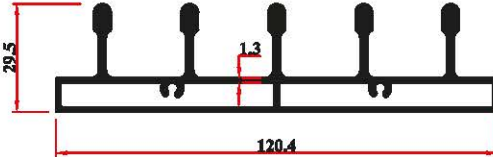
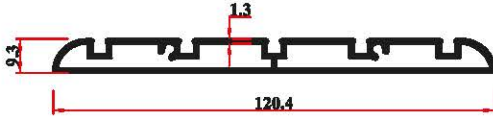

**AĞIRLIK:1,067 kg/mt**

jx:48,580 cm<sup>4</sup>

jy:0,822 cm<sup>4</sup>

Alt Ray(Eşiksiz)

**1,804 kg/mt**

jx:80,312 cm<sup>4</sup>

jy:5,895 cm<sup>4</sup>

Alt Ray(Esikli)

**0,300 kg/mt**

jx:1,085 cm<sup>4</sup>

jy:0,530 cm<sup>4</sup>

Yan Dikme U(Dar)

### SİSTEM NUMARASI

95 SGS 1374

95 SGS 1376

95 SGS 1378

95 SGS 1380

### KALIP NUMARASI

1374

1376

1378

1380

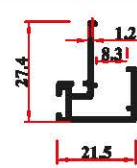
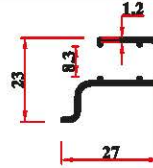
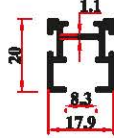
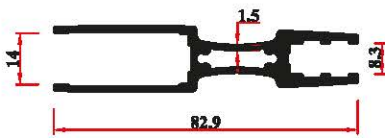

**AĞIRLIK:1,051 kg/mt**

jx:20,12 cm<sup>4</sup>

jy:1,453 cm<sup>4</sup>

Alt Baza Profili(çşikli-çşiksiz)

**0,267 kg/mt**

Fitilli Üst Cam Profili

**0,211 kg/mt**

Kulplu Yan Dikme Profili

**0,267 kg/mt**

Fitilli Orta Kenet profili

### SİSTEM NUMARASI

95 SGS 1375

95 SGS 1377

95 SGS 1379

95 SGS 1381

### KALIP NUMARASI

1375

1377

1379

1381

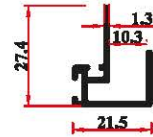
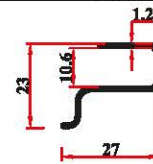
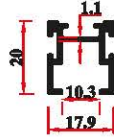
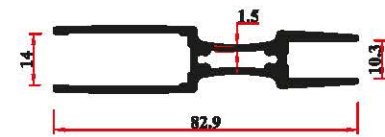

**AĞIRLIK:0,988 kg/mt**

jx:17,489 cm<sup>4</sup>

jy:1,371 cm<sup>4</sup>

Alt Baza Profili(çşikli-çşiksiz)

**0,254 kg/mt**

Fitilli Üst Cam Profili

**0,200 kg/mt**

Kulplu Yan Dikme Profili

**0,267 kg/mt**

Fitilli Orta Kenet profili

SİSTEM NUMARASI

95 SGS 1373

95 SGS 1383

KALIP NUMARASI

1373

1383

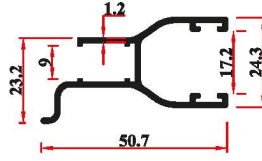
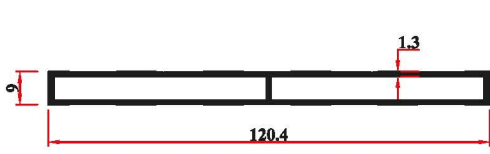

**AĞIRLIK:0,845 kg/mt**

**0,421 kg/mt**

jx:41,574 cm<sup>4</sup>

jx:3,230 cm<sup>4</sup>

iy:0,426 cm<sup>4</sup>

iy:1,120 cm<sup>4</sup>

Yan Dikme

Kulplu Orta Dikme Profili

ÖLÇEK:1/2

AKSESUAR KODU	AKSESUAR RESMİ	AKSESUAR KODU	AKSESUAR RESMİ
95 SGS A02 Eşikli Kapak		95 SGS A08 Eşiksiz Kapak	
95 SGS A03 Eşikli Düz Kapak		95 SGS A09 Eşiksiz Düz Kapak	
95 SGS A10 Alt Teker Eşikli		95 SGS A11 Alt Teker Eşiksiz	
95 SGS A13 Fişek Sürgü		95 SGS A12 Üst Teker	
95 SGS A14 Kilit Takımı		95 SGS A14-1 Kilit Takımı	
95 SGS F65 Orta Kenet Fıtili USN-65 1 Kolide 250 m / 10 kg		95 SGS A04 Gömme Kulp Paslanmaz Delik Çapı :Ø 45mm	
95 SGS A01-1 Üst Ray ve Kenet Kıl Fıtil (67 / 500 mm)		95 SGS A01 Yan Dikme Kıl Fıtil (67 / 1200 mm)	

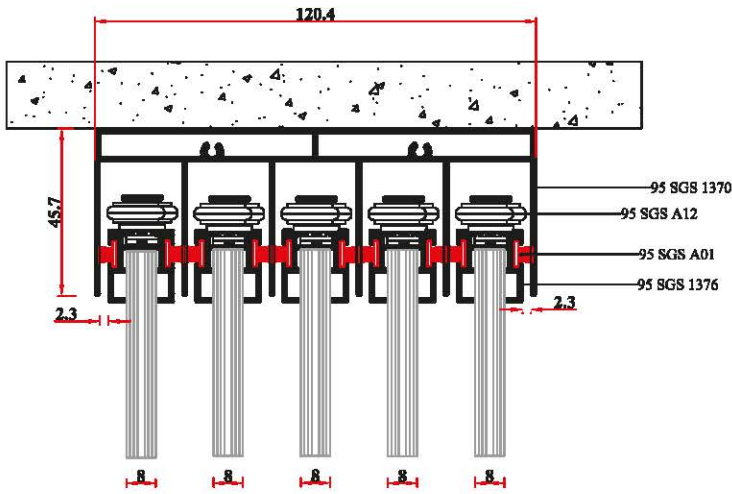

1 NOLU DETAY

ÖLÇEK:1/2

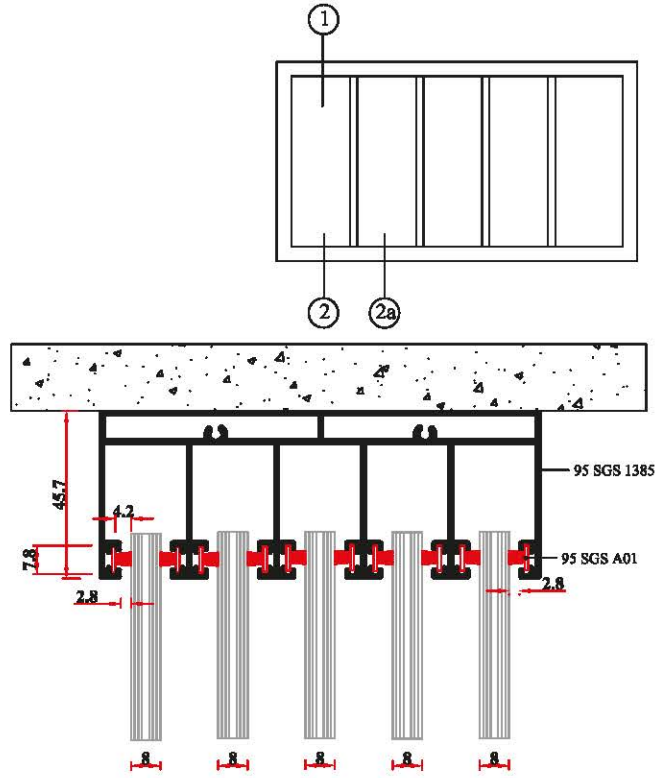

1 NOLU DETAY (ALTERNATİF)

ÖLÇEK:1/2

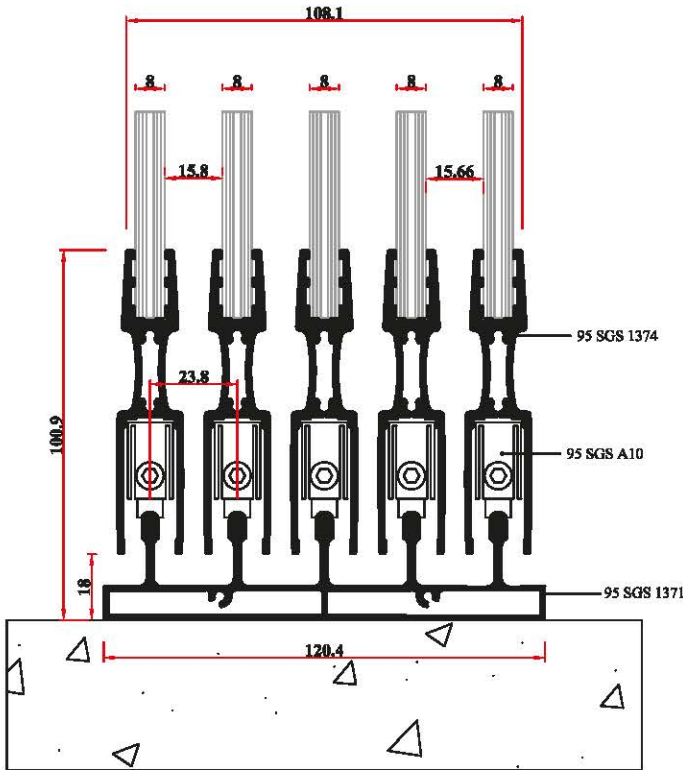

2 NOLU DETAY

ÖLÇEK:1/2

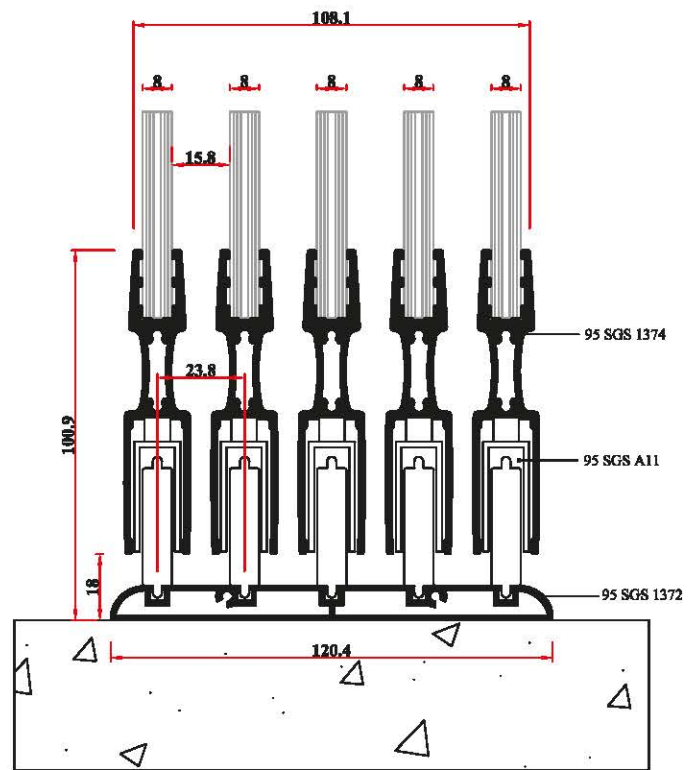

2a NOLU DETAY

ÖLÇEK:1/2



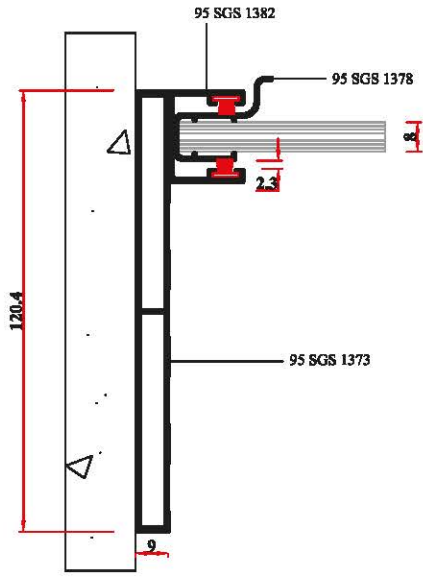

1 NOLU DETAY

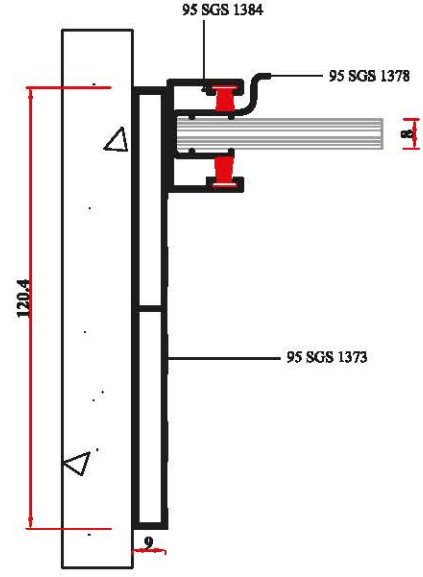
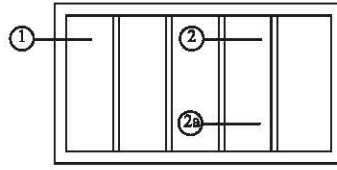

1 NOLU DETAY (ALTERNATİF)

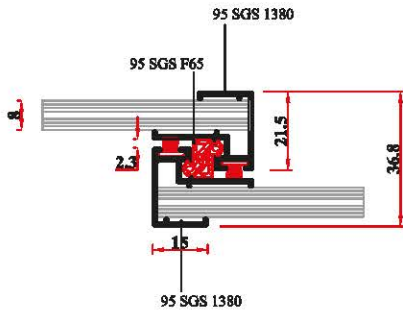

2 NOLU DETAY

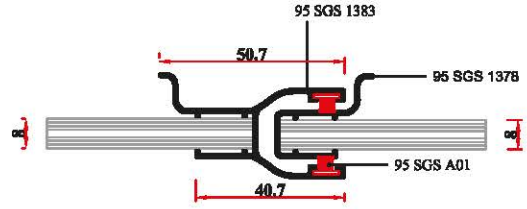

2A NOLU DETAY

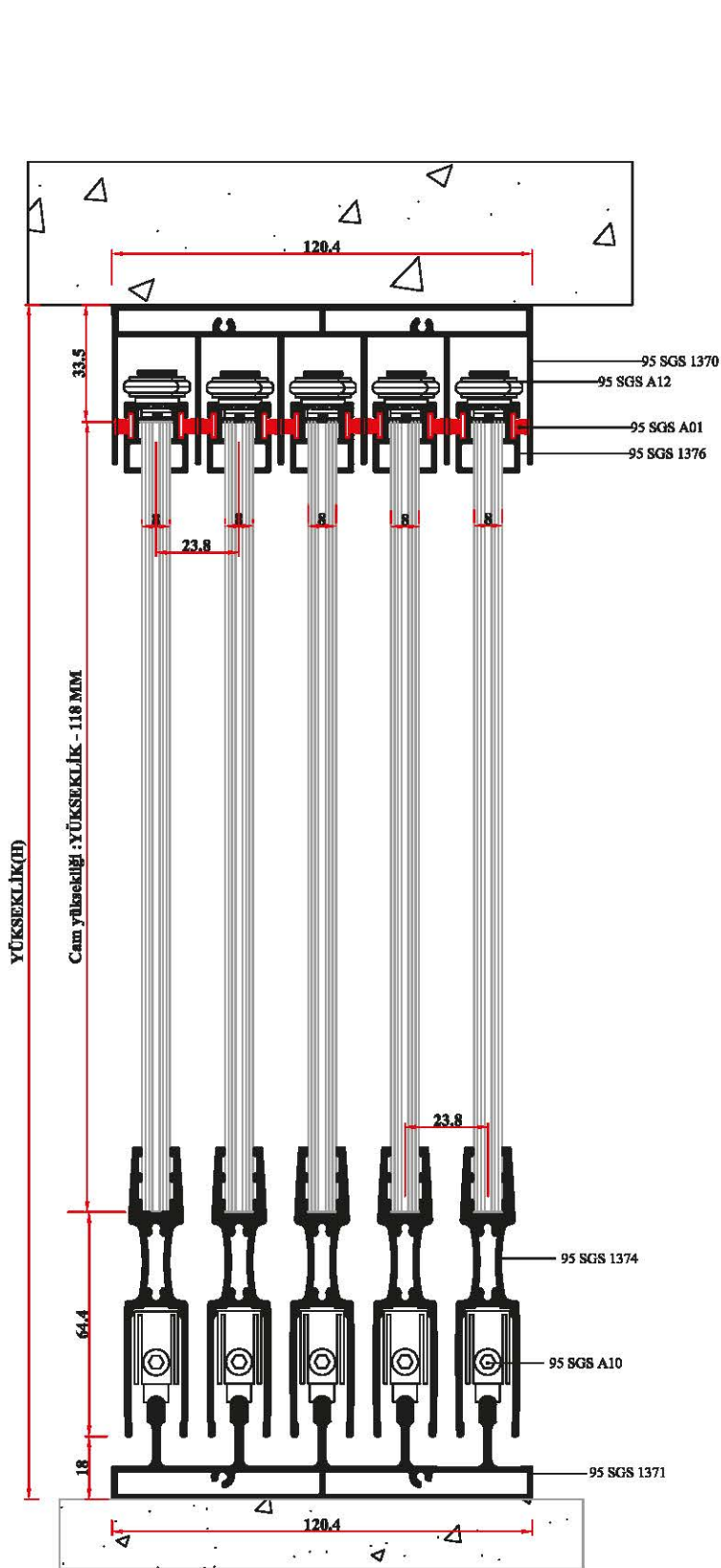

1 NOLU DETAY

ÖLÇEK:1/2

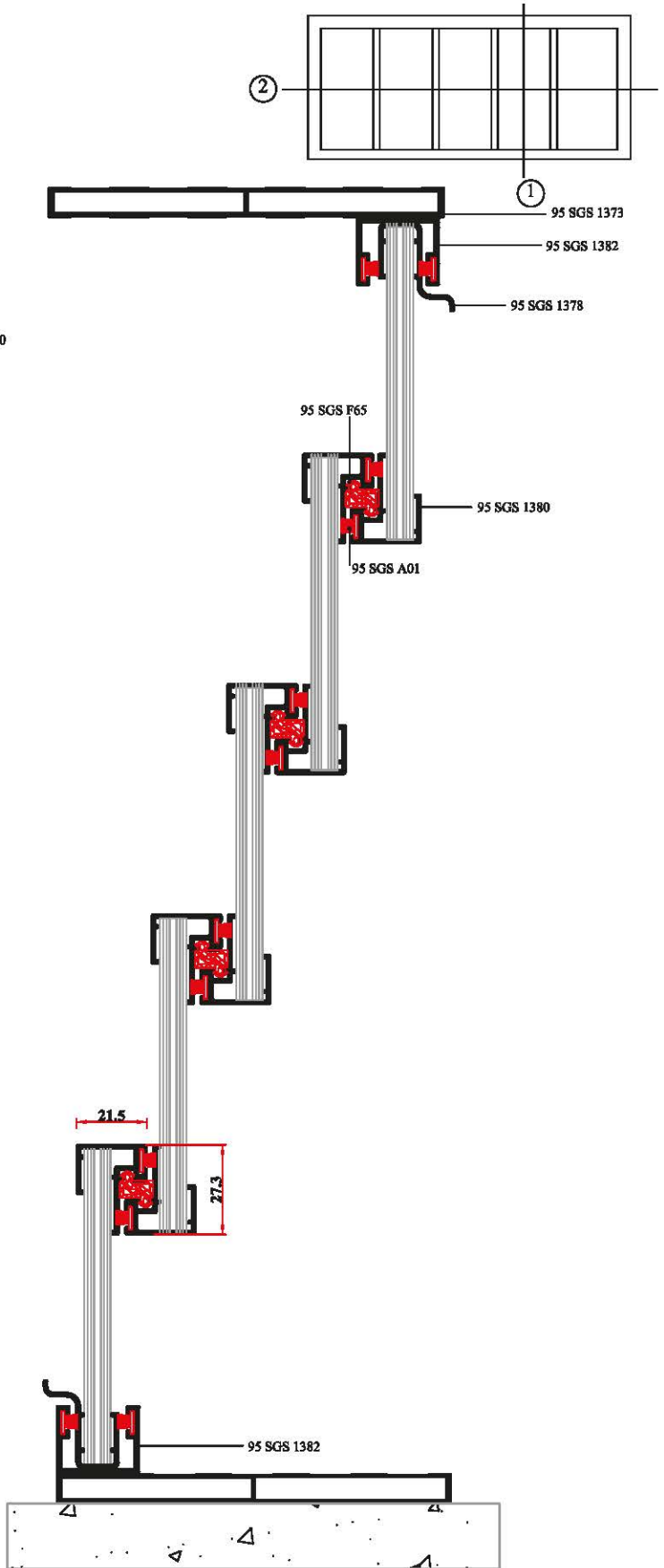

ÖLÇEK:1/2

2 NOLU DETAY



