



ULUSAN[®]
aluminium profiles technology



ARWIS DORSE SİSTEM SERİSİ

AD



AD



ARWIS DORSE SİSTEM SERİSİ

ARWIS TRAILER SYSTEM SERIES

SİSTEM NUMARASI

AD 2513

AD 2508

AD 2507

KALIP NUMARASI

2513

2508

2507

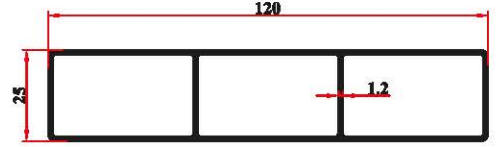
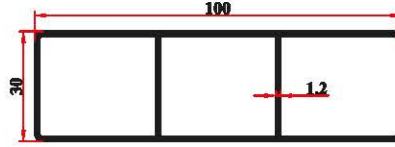
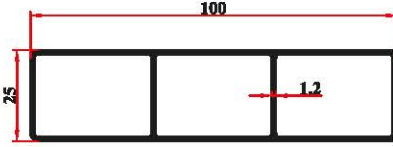

AĞIRLIK:0,936 kg/mt

0,996 kg/mt

1,067 kg/mt

25 mm Tahtalık Profili

30 mm Tahtalık Profili

120 mm Tahtalık Profili

SİSTEM NUMARASI

AD 5041

AD 2523

KALIP NUMARASI

5041

2523

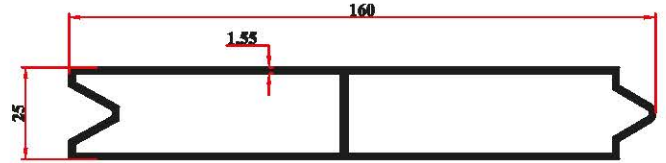
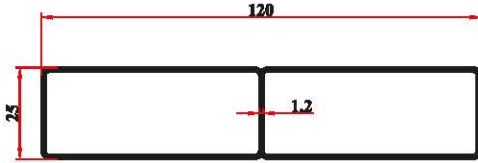

AĞIRLIK:0,990 kg/mt

1,652 kg/mt

Tahtalık Profili

Üçgen Tahtalık Profili

SİSTEM NUMARASI

AD 5143

AD 2509

AD 2504

KALIP NUMARASI

5143

2509

2504

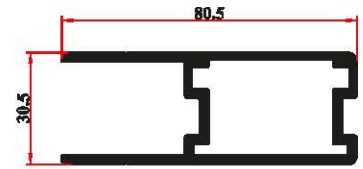
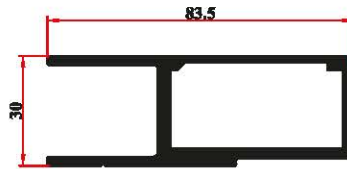
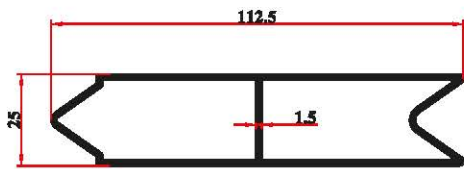

AĞIRLIK:1,183 kg/mt

1,638 kg/mt

1,497 kg/mt

Üçgen Tahtalık Profili

Yan Kilit Profili

Dorse Kilit Profili

SİSTEM NUMARASI

AD 2511

AD 2512

AD 2519

AD 2522

KALIP NUMARASI

2511

2512

2519

2522

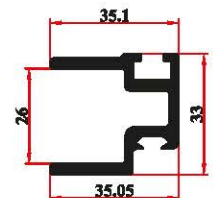
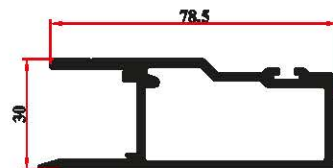
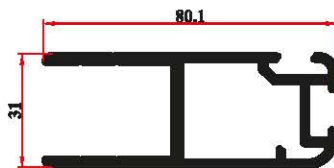
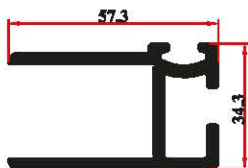

AĞIRLIK:1,328 kg/mt

1,481 kg/mt

1,347 kg/mt

0,815 kg/mt

Yarım Üst Profili

Arka U Profili

Yan Kilit Profili

ÖLÇEK:1/2

PROFİLLERİN BİRİM AĞIRLIKLARI TEORİK OLARAK HESAPLANMIŞTIR / PROFILES UNIT WEIGHTS CALCULATED THEORETICALLY

SİSTEM NUMARASI

AD 2505

AD 2521

AD 2520

AD 5052

KALIP NUMARASI

2505

2521

2520

5052

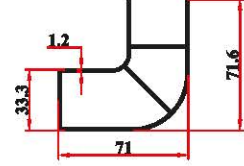
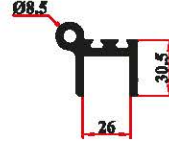
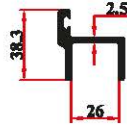
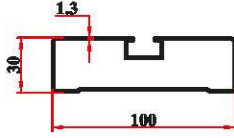
**AĞIRLIK:1,002 kg/mt****0.775 kg/mt****1.212 kg/mt****0.964 kg/mt****Bisikletlik Profil****Bisikletlik Köşe Dönüş Profili**

SİSTEM NUMARASI

AD 2561

AD 5155

KALIP NUMARASI

2561

5155

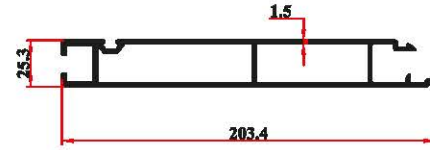
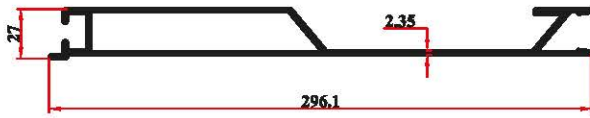
**AĞIRLIK:2,770 kg/mt****2,195 kg/mt****Dorse Alt Profil****Dorse Alt Profil**

SİSTEM NUMARASI

AD 2515

AD 2571

AD 2572

KALIP NUMARASI

2515

2571

2572

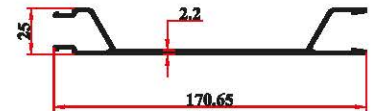
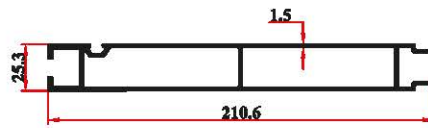
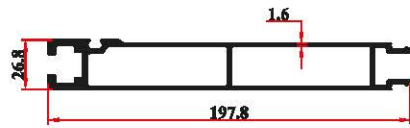
**AĞIRLIK:2,534 kg/mt****2,244 kg/mt****1,375 kg/mt****Dorse Alt Profil****Eco Seri Alt Profil****Eco Seri Kanallı Profil**

SİSTEM NUMARASI

AD 2573

AD 2516

AD 5068

KALIP NUMARASI

2573

2516

5068

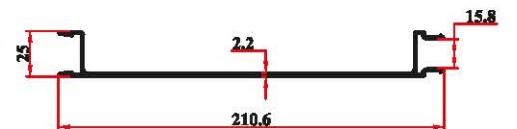
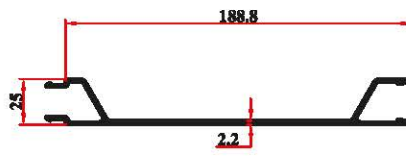
**AĞIRLIK:1,611 kg/mt****1,547 kg/mt****1,582 kg/mt****Eco Seri 200 lük Kanallı Profil****Kanallı Profil****Kanallı Profil**

ÖLÇEK:1/4

SİSTEM NUMARASI

AD 2562

AD 2510

AD 2517

KALIP NUMARASI

2562

2510

2517

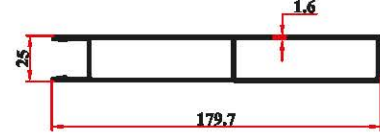
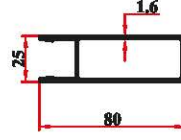
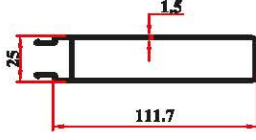
**AĞIRLIK:1,244 kg/mt****1,006 kg/mt****1,944 kg/mt****Üst Profil****Yarım Üst Profil****Tam Üst Profil**

SİSTEM NUMARASI

AD 2574

AD 5027

AD 2555

KALIP NUMARASI

2574

5027

2555

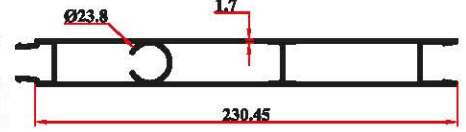
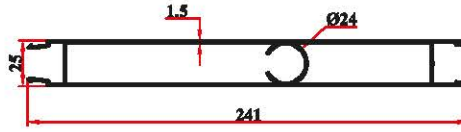
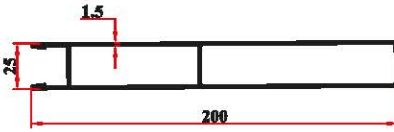
**AĞIRLIK:1,939 kg/mt****2,397 kg/mt****2,881 kg/mt****Eco Seri Üst Profil****Orta Delikli Profil****Orta Delikli Profil**

SİSTEM NUMARASI

AD 2529

AD 2518

KALIP NUMARASI

2529

2518

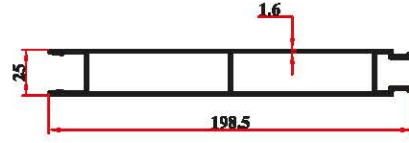
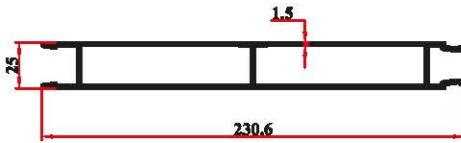
**AĞIRLIK:2,273 kg/mt****2,144 kg/mt****Dorse Orta Profil****Dorse Ota Profil**

SİSTEM NUMARASI

AD 5026

AD 5029

KALIP NUMARASI

5026

5029

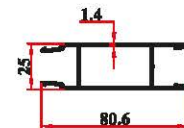
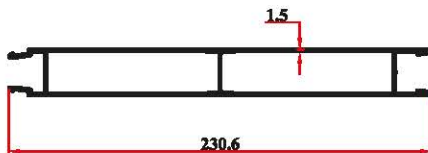
**AĞIRLIK:2,205 kg/mt****0,845 kg/mt****Dorse Ota Profil****Dorse Ota Profil**

ÖLÇEK:1/4

SİSTEM NUMARASI

AD 2576

AD 2563

AD 2560

AD 2552

KALIP NUMARASI

2576

2563

2560

2552

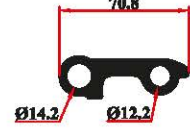
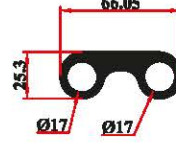
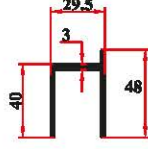
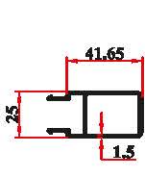
**AĞIRLIK:0.672 kg/mt****0.674 kg/mt****2,060 kg/mt****2,034 kg/mt****Kısa Üst Profili****U Profili****Mentese Profili****Mentese Profili**

SİSTEM NUMARASI

AD 2551

AD 2550

AD 5038

AD 2536

KALIP NUMARASI

2551

2550

5038

2536

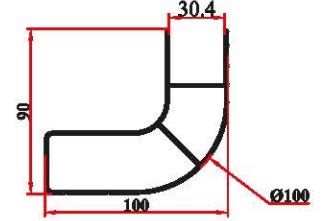
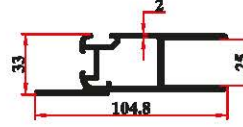
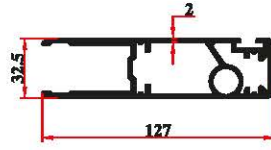
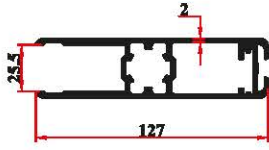
**AĞIRLIK:2,541 kg/mt****2,677 kg/mt****1,763 kg/mt****1,716 kg/mt****Arka Kapak U Profili****Arka Kapak U Profili****Arka Kapak U Profili****Bisikletlik Köşe Dönüş Profili**

SİSTEM NUMARASI

AD 2525

AD 2524

KALIP NUMARASI

2525

2524

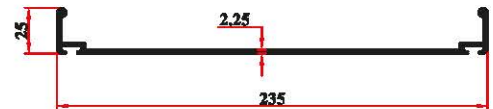
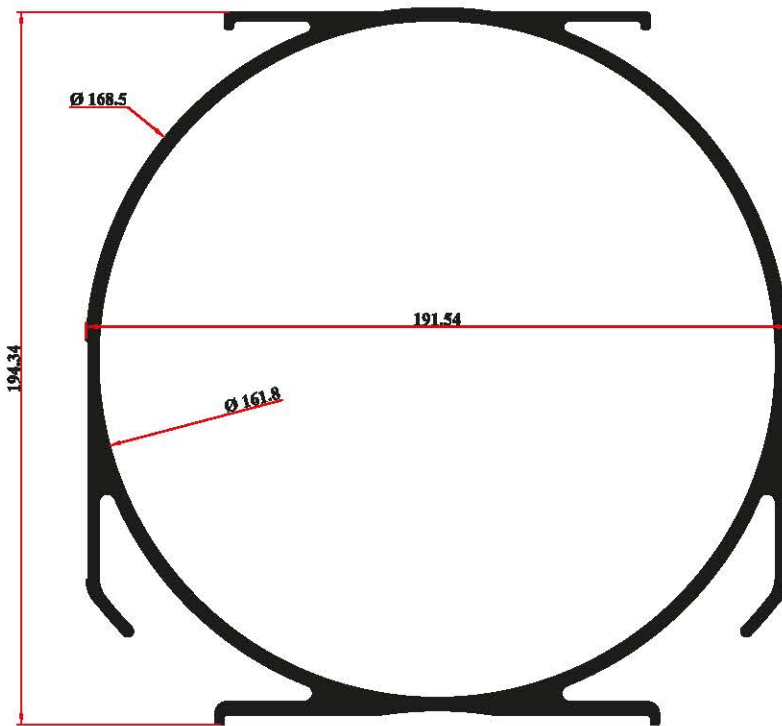
**AĞIRLIK:6,065 kg/mt****1,836 kg/mt****Tanker Yan Hortum Profili****Tanker Yan Kapama Profili**

SİSTEM NUMARASI

AD 5007

AD 2547

AD 5008

KALIP NUMARASI

5007

2547

5008

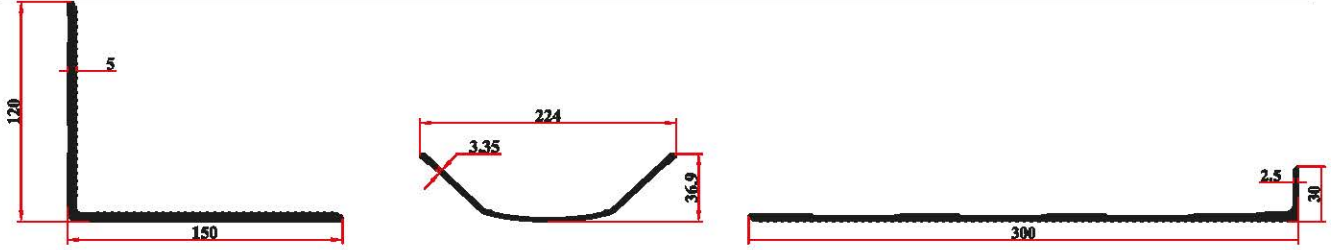

AĞIRLIK:3,208 kg/mt

2,265 kg/mt

2,752 kg/mt

Frigofrik Profili

Frigofrik Profili

Frigofrik Profili

SİSTEM NUMARASI

AD 5014

AD 5031

AD 2544

AD 2054

AD 2549

KALIP NUMARASI

5014

5031

2544

2054

2549

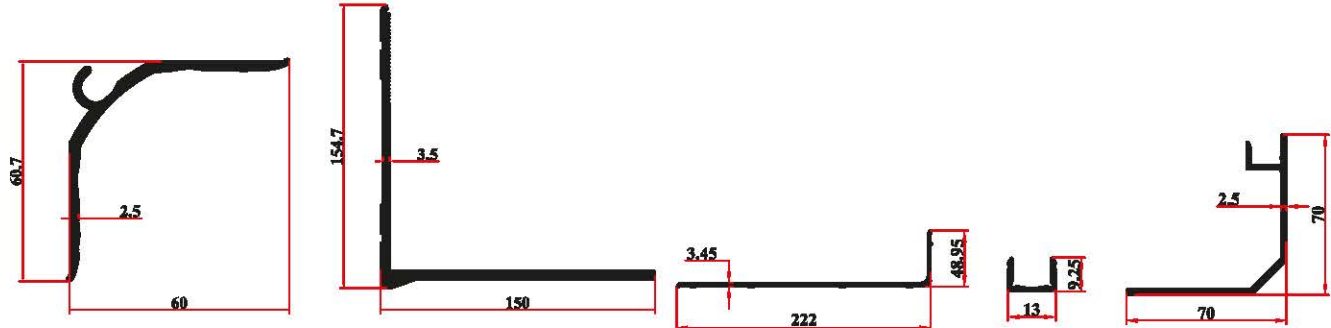

AĞIRLIK:0,782 kg/mt

3,701 kg/mt

2,305 kg/mt

0,090 kg/mt

1,001 kg/mt

Frigofrik Profili

Frigofrik Profili

Frigofrik Profili

40 lık Çıta

Çıtalı Ön Köşe Profili

SİSTEM NUMARASI

AD 2546

AD 2545

AD 2548

KALIP NUMARASI

2546

2545

2548



AĞIRLIK:2,366 kg/mt

2,853 kg/mt

1,749 kg/mt

Frigofrik Profili

Frigofrik Profili

Frigofrik Profili

SİSTEM NUMARASI

AD 5032

AD 2533

AD 2587

AD 2534

KALIP NUMARASI

5032

2533

2587

2534

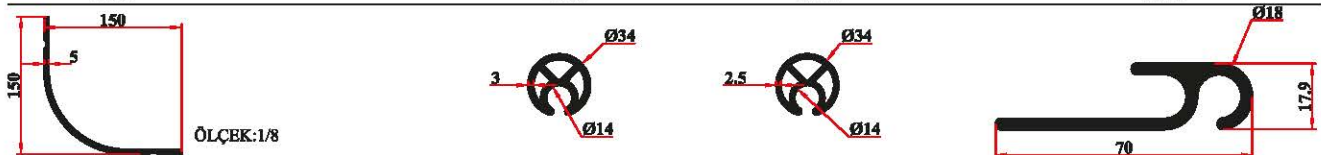

AĞIRLIK:3,321 kg/mt

1,212 kg/mt

1,046 kg/mt

0,940 kg/mt





















Arka Kapak U Profili









Gergi Çubuğu Profili

Gergi Çubuğu Profili

Gergi Çubuğu Kanca Profili

ÖLÇEK:1/4

AKSESUAR KODU	AKSESUAR RESMİ	AKSESUAR KODU	AKSESUAR RESMİ
AD A02 Alüminyum Bisikletlik Bariyer Başlığı (2505 de kullanılır)		AD A03 Bisiklet Köşe Tapası (2536 da kullanılır)	
AD A05 Alüminyum Tahtalık Başlığı İçer Geçmeli (2507 de kullanılır)		AD A06 Alüminyum Bariyer Başlığı İçer Geçmeli (5041 ve 2507 de kullanılır.)	
AD A07 Plastik Mentşe Yatak Takımı		AD A08 Gizli Sistem U Mentşe	
AD A09 Gizli Sistem Döküm Mentşe		AD A10 Döküm Dorse Mentşe (Dişi)	
AD A11 Döküm Dorse Mentşe (Erkek)		AD A12 Mentşe Silmesi Arka Kapak	
AD A13 Mentşe Silmesi Yan Kapak		AD A14 Gizli Sistem Kilit Üst Fiber Saç	
AD A15 Gizli Sistem Kilit Alt Fiber Saç		AD A16 Çadır Kancası (Oynar başlı)	
AD A17 Çadır Kancası (Radyüslü)		AD A18 Çadır Kancası (Sabit)	
AD A19 Dikey Kilitleme Sistemi Mekanizması		AD A20 Gizli Sistem Arka Kapı Kilidi	 
AD A21 T Başlı Gömme Dorse Kilidi		AD A22 T Başlı Gömme Dorse Kilit Başlığı	

AKSESUAR KODU	AKSESUAR RESMİ	AKSESUAR KODU	AKSESUAR RESMİ
AD A23 Kutu profil Dikey Kilitleme Sistemi		AD A24 Arka Kapı Tutamağı	
AD A25 Arka Kapak Mentеше Saplama		AD A26 4.8x14 Çelik Perçin	
AD A26-1 6.4x14 Çelik Perçin		AD A27 Alüminyum Dövmе Perçin	
AD A28 Mentеше Plastik		AD A28-1 Mentеше Plastik	
AD A28-2 Kilit Fiber Plastik		AD A28-3 Kilit Fiber Plastik	
AD A29 5x30'luk Yarıklı Pim		AD A30 5x7'luk Yarıklı Pim	
AD A32 Dik Kilit Pimi		AD A33 10x20 İmbus Vida	
AD A33 8x20 İmbus Vida		AD A35 USN 01 Arka Kapak Orta Fitol USN-01 1 Kolide 30 m / 15 kg	
AD A36 USN 02 Arka Kapak Fitol USN-02 1 Kolide 50 m / 10 kg		AD A37 USN 29 Arka Kapak Orta Fitol USN-29 1 Kolide 39 m / 10 kg	
AD A38 USN 04 Yan Kapak Fitol USN-04 1 Kolide 150 m / 15 kg		AD A39 Mega Mentеше	

AKSESUAR KODU	AKSESUAR RESMİ	AKSESUAR KODU	AKSESUAR RESMİ
AD A40 Mega Mentşe		AD A41 Arka Kapak Kilit Silmesi	
AD A42 Yaylı Çadır Mentşesi		AD A43 USN 26 Arka Kapak Fiteli USN-26 1 Kolide 75 m / 16 kg	
AD A44 USN 25 Arka Kapak Orta Fital USN-25 1 Kolide 40 m / 14 kg		AD A45 USN 27 Yan Kapak Fitali USN-27 1 Kolide 250 m / 12 kg	

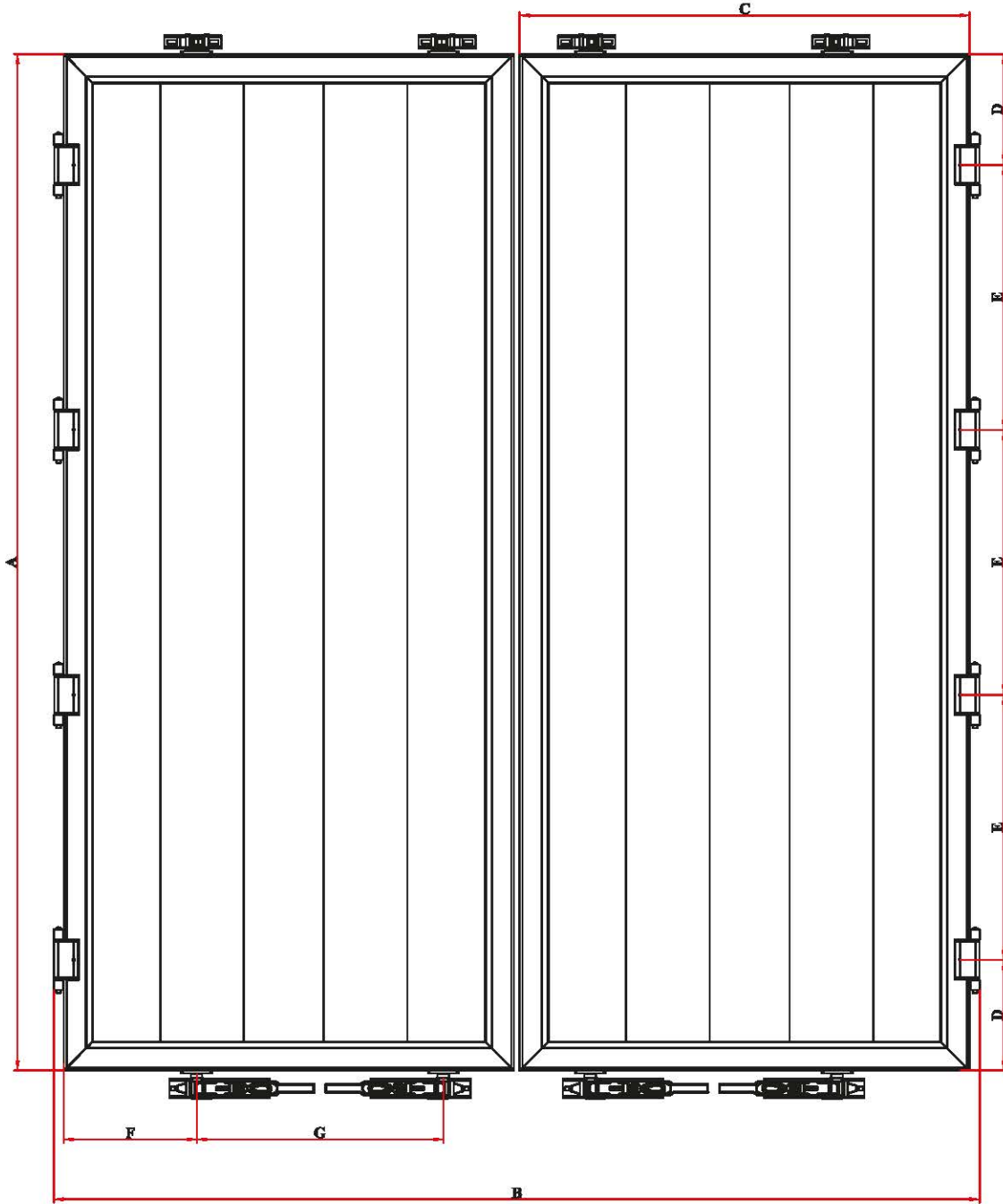

KAPAK ÖLÇÜLERİ / COVER SIZES	SEMBOL SYMBOL	2800X2550 MM
KAPAK BOYU/ COVER LENGHT	A	2800
KAPAK GENİŞLİK / COVER WIDTH	B	2550
KANAT GENİŞLİĞİ / WING WIDTH	C	1240
MENTEŞE BAŞLANGIÇ MESAFESİ HINGE START DISTANCE	D	305
MENTEŞELER ARASI MESAFE DISTANCE BETWEEN HINGES	E	730
KİLİT BAŞLANGIÇ MESAFESİ LOCK START DISTANCE	F	365
KİLİTLER ARASI MESAFE DISTANCE BETWEEN LOCKS	G	680

Tırsan Tipi Arka Kapak / Back Cover

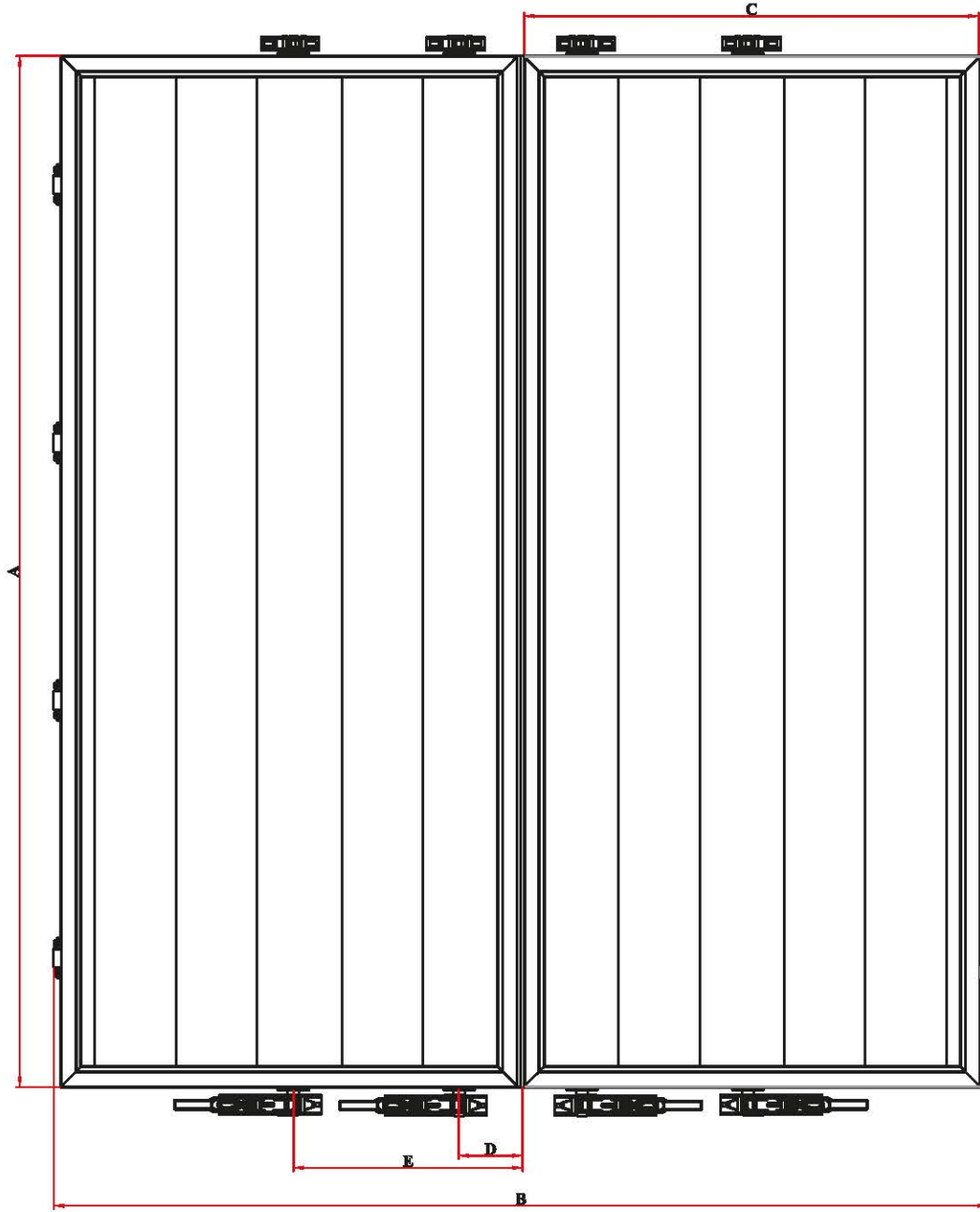

KAPAK ÖLÇÜLERİ / COVER SIZES	SEMBOL SYMBOL	2800X2530 MM
KAPAK BOYU/ COVER LENGHT	A	2800
KAPAK GENİŞLİK / COVER WIDTH	B	2530
KANAT GENİŞLİĞİ / WING WIDTH	C	1243
KİLİT BAŞLANGIÇ MESAFESİ LOCK START DISTANCE	D	160
2.KİLİT MERKEZ ÖLÇÜSÜ SECOND LOCK CENTER MEASUREMENT	E	610

Serin Tipi Arka Kapak / Back Cover

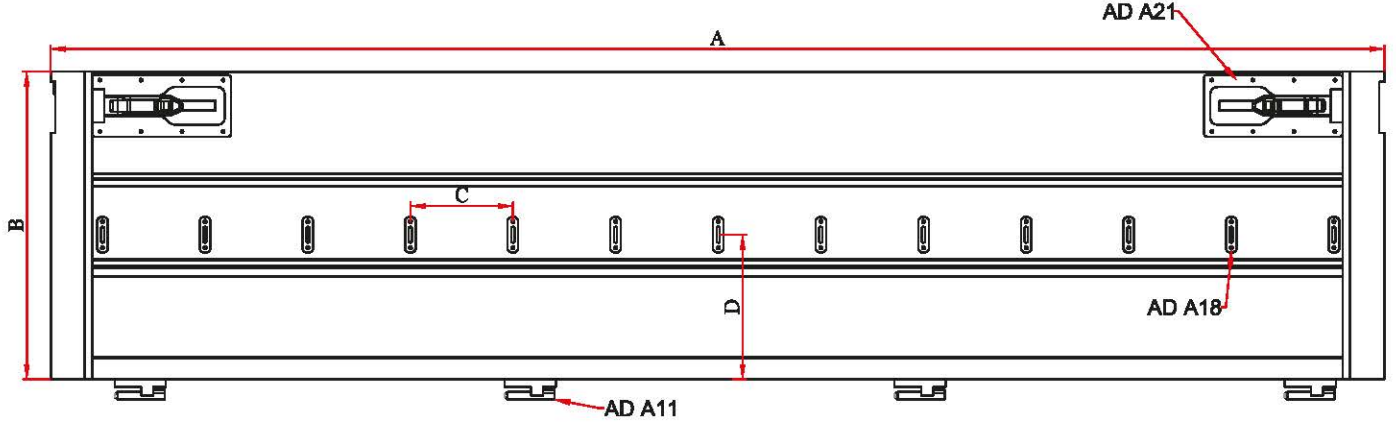

KAPAK ÖLÇÜLERİ COVER SIZES	SEMBOL SYMBOL	2560X600 MM
KAPAK BOYU COVER LENGTH	A	2560
KAPAK YUKSEKLİĞİ COVER HEIGHT	B	600
KANCALAR ARASI MESAFE DISTANCE BETWEEN HOOKS	C	200
KANCA MERKEZ ÖLÇÜSÜ HOOK CENTER DISTANCE	D	283

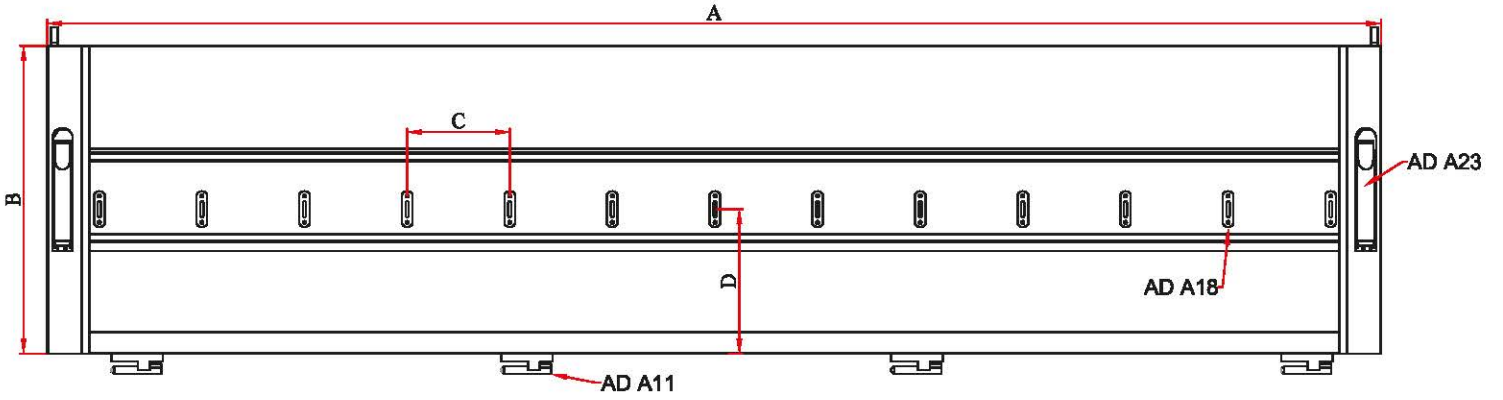
Yan Kapak / Side Cover

KAPAK ÖLÇÜLERİ COVER SIZES	SEMBOL SYMBOL	2560X600 MM
KAPAK BOYU COVER LENGTH	A	2560
KAPAK YUKSEKLİĞİ COVER HEIGHT	B	600
KANCALAR ARASI MESAFE DISTANCE BETWEEN HOOKS	C	200
KANCA MERKEZ ÖLÇÜSÜ HOOK CENTER DISTANCE	D	283

Yan Kapak / Side Cover

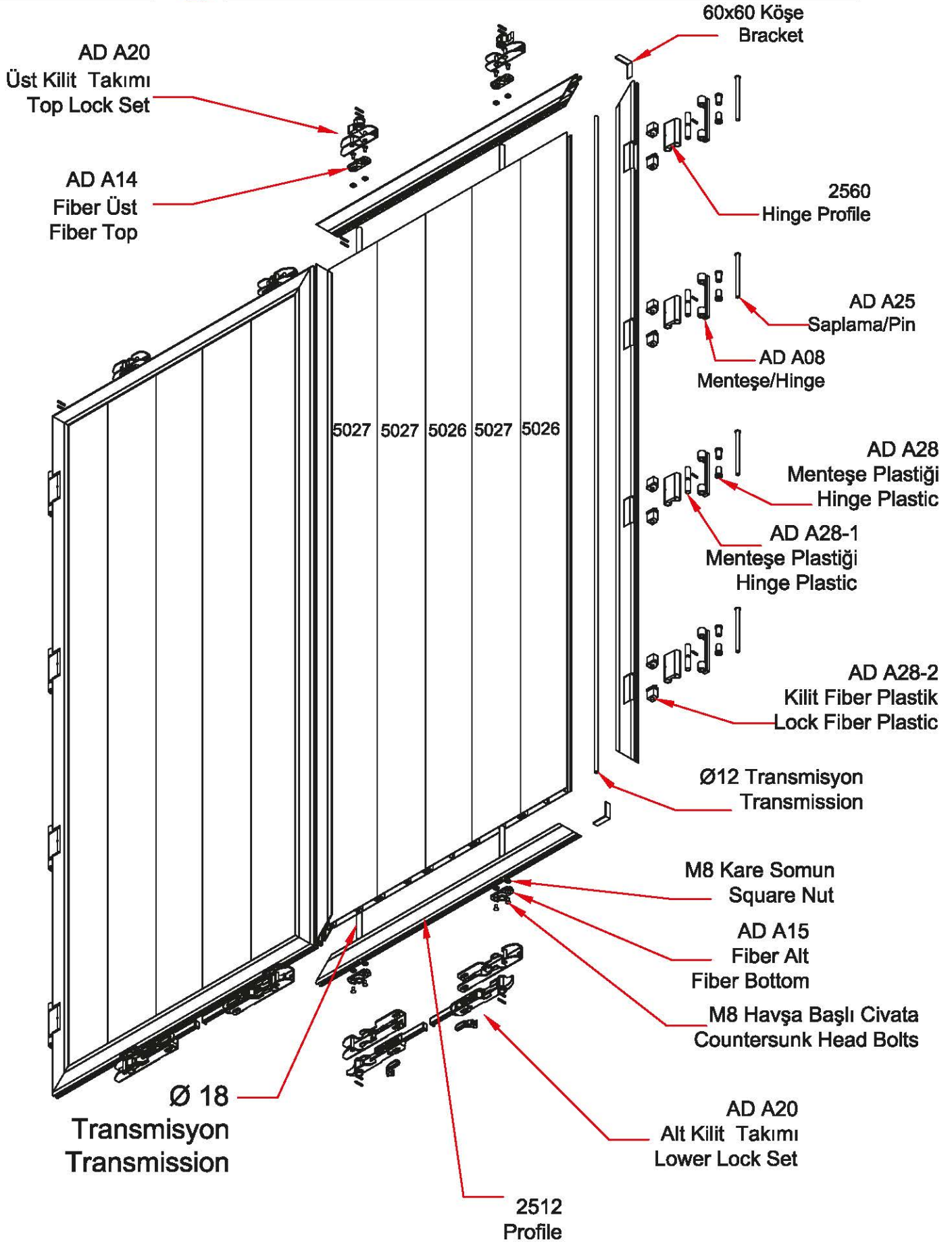
Tırsan Tipi Arka Kapak / Back Cover

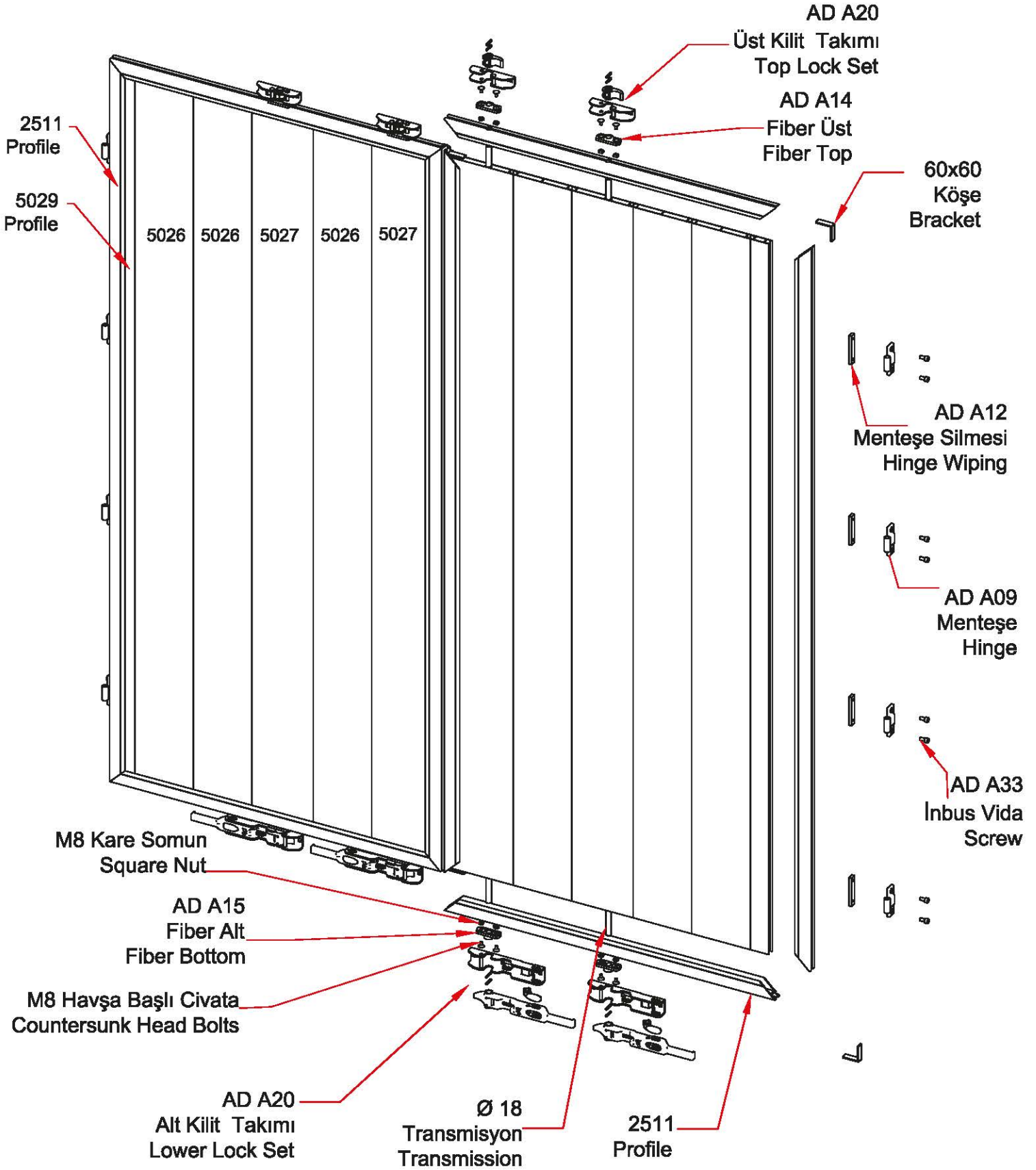
Serin Tipi Arka Kapak / Back Cover